



热处理领域的 探索者、先行者、领航者

BE AN EXPLORER & PIONEER & LEADER
IN THE FIELD OF HEAT TREATMENT

COMPANY PROFILE

关于皓越 >>>



上海皓越真空设备有限公司，简称“皓越科技”，创立于2009年，是一家集研发、设计、生产、销售为一体的国家级高新技术企业；产品涵盖先进陶瓷及复合材料设备、半导体材料设备、锂电材料及新能源设备三大领域。

目前，公司拥有大型现代化标准厂房、成套的加工设备、完善的质量管理体系，同时拥有先进的设备展厅以及超过 1500m² 的热处理研发中心实验室，实验室不仅可供公司内部科研探索，同时也可供外部高校、科研院所、企业等做实验研发。

公司长期聚焦深耕于行业，荟聚了一批长期从事热处理炉、真空炉及特种炉制造和服务的技术精英，目前拥有60多项专利成果和软件著作权，具备年产200套热处理炉、60套大型真空炉的生产能力；业务覆盖欧洲、美洲、中东以及东南亚市场；此外，公司长期与复旦大学、同济大学、哈尔滨工业大学、南京航空航天大学等保持科研合作，共同打造了产学研基地和人才培养基地；同时与华为、宁德时代、天通控股、三安光电、中船重工、中航集团、中电集团等客户达成合作，特别在高精度的温控领域、真空系统、自动化控制以及计算机分析体系等方面保持领先地位，为客户提供了完善的一体化产业解决方案。

立足长三角，面向全国，打造国际化的品牌，十多年的稳健经营和高效发展，展示着皓越科技不断的追求；显著的经营业绩，记录着皓越科技不懈的努力；皓越科技始终秉持“正直、专注、卓越、创新、致远”的核心价值观，继续坚持“推动热处理快速发展，创造价值，回报社会”的使命，向“新材料、新能源热处理领域的领航者”的宏伟愿景奋进。

高屋建瓴，开拓创新，创新的产品、可靠的质量、诚信的服务，皓越科技期待与您携手共创美好未来！

Shanghai Haoyue Technology Co., Ltd.(Haoyue Technology), was founded in 2009. It is a high-tech enterprise that integrates R&D, production, and sales; Our products cover three major fields: advanced ceramic & composite material equipment, semiconductor material equipment, lithium battery materials & new energy equipment.

At present, the company has over 7000m² factory building, a complete set of processing equipment, a good quality management system, and an advanced equipment exhibition hall as well as a heat treatment R&D center laboratory of over 1500m². The laboratory is not only available for internal scientific research and exploration, but also for external universities, research institutes, enterprises to conduct experimental research and development.

The company has focused on the industry, gathering a group of technical elites who have been engaged in the manufacturing and service of heat treatment furnaces, vacuum furnaces, and special furnaces for a long time. Currently, it has more than 60 patent achievements and software works, and has the production capacity to produce 200 sets of heat treatment furnaces and 60 sets of large vacuum sintering furnaces annually; Our business covers markets in Europe, America, the Middle East, and Southeast Asia; In addition, the company has maintained long-term scientific research cooperation with Fudan University, Tongji University, Harbin Institute of Technology, Nanjing University of Aeronautics and Astronautics, and other universities, jointly building industry university research bases and talent training bases; At the same time, we have established cooperation with customers such as Huawei, CATL, Tiantong Holdings, Sanan Optoelectronics, China Shipbuilding Heavy Industry Corporation, AVIC Group, and China Electronics Corporation. We maintain a leading position in high-precision temperature control, vacuum systems, automation control, and computer analysis systems, providing customers with comprehensive integrated industrial solutions.

Based in the Yangtze River Delta, facing the whole China, building an international brand, with more than 15 years of stable operation and efficient development, showcasing the continuous pursuit of Haoyue Technology; Significant business performance records the unremitting efforts of Haoyue Technology; Haoyue Technology always adheres to the core values of "integrity, focus, excellence, innovation, and long-term development", continues to adhere to the mission of "promoting the rapid development of heat treatment, creating value, and repaying to society", and strives to become a leader in the field of new materials and new energy heat treatment.

From a high perspective, we strive for innovation, reliable quality, and honest service. Haoyue Technology looks forward to working together with you to create a better future!

C O N T E N T S

目录

S系列放电等离子烧结系统 01 S serie Spark PlasmaSintering (SPS) System	V系列真空炉(钨带加热) 19 V series Vacuum Furnace(Tungsten)
S系列放电等离子混合烧结系统 03 S serie Spark PlasmaSintering (SPS+Induction) System	V系列真空炉(感应加热) 21 V series Vacuum Furnace(Induction)
S系列半连续式等离子烧结系统 05 S serie Spark Plasma Semi-continuous Sintering (SPS) System	V系列连续式真空炉(石墨加热) 23 V series Continuous Vacuum Furnace(graphite)
S系列连续式等离子烧结系统 07 S serie Spark Plasma Continuous Sintering (SPS) System	G系列气压烧结炉 25 G series Gas Pressure Sintering Furnace
P系列真空热压炉(石墨加热) 09 P series Vacuum Hot Pressing Furnace (Graphite)	H系列氢气炉 27 H series Hydrogen Furnace
P系列真空热压炉(感应加热) 11 P series Vacuum Hot Pressing Furnace (Induction)	C系列气相沉积炉 29 C series CVD (Chemical vapor deposition) Furnace
P系列连续式热压炉(石墨加热) 13 P series Continuous Hot Pressing Furnace (Graphite)	D系列真空扩散焊炉 31 D series Vacuum Diffusion Welding Furnace
V系列真空炉(石墨加热) 15 V series Vacuum Furnace (Graphite)	R系列间歇式回转窑 33 R series Rotary Furnace
V系列真空炉(钼带加热) 17 V series Vacuum Furnace (Moly)	R系列连续式回转窑 35 R series Continuous Rotary Furnace

Spark Plasma Sintering

SPS放电等离子烧结系统

S Series



升温速度快 / 烧结时间短 / 组织结构可控 / 节能环保

Fast Heating Rate / Short Sintering Time / Controllable Organizational Structure /
Energy-saving and Environmental Protection

简介 / BRIEF INTRODUCTION

SPS(Spark Plasma Sintering)放电等离子烧结系统是当今世界上最先进的烧结系统之一，是在两电极间施加脉冲电流和轴向压力进行粉末烧结致密化的一种新型快速烧结技术。它具有升温速度快、烧结时间短、组织结构可控、节能环保等鲜明特点，可用于制备金属材料、陶瓷材料、复合材料，也可用来制备纳米块体材料、非晶块体材料、梯度材料等。

The SPS (Spark Plasma Sintering) DCS discharge plasma sintering system is one of the most advanced sintering systems in the world today. It is a new rapid sintering technology that applies pulse current and axial pressure between two electrodes to densify powder sintering. It has distinct characteristics such as fast heating rate, short sintering time, controllable organizational structure, energy conservation and environmental protection. It can be used to prepare metal materials, ceramic materials, composite materials, as well as nano bulk materials, amorphous bulk materials, gradient materials, etc.

S6等轴测图

S6 Isometric View



技术特点 / ADVANTAGES

由于SPS过程中施加直流脉冲电流产生放电效应而带来的一些特有现象，有以下几个特点：

- 可以快速升温，快速冷却，大幅缩短生产时间，降低生产成本（升温速率可达200°C/min）；
- 烧结温度低（与热压烧结相比，烧结温度可进一步降低）；
- 具有独特的净化、活化效应（消除粉末颗粒表面吸附气体，击穿氧化膜），轻松实现难烧结材料、多元素材料的烧结；
- 相比于传统烧结工艺，可以在更短的时间内得到组织性质更均匀、更致密、晶粒尺寸更小的材料；
- 相比于传统烧结工艺，可大幅节省电能；
- 采用我司专业直流脉冲电源技术，具有烧结速度快、稳定可靠，节能效果好；
- 压力精度高：采用伺服压力控制系统，压力精度为±3%；
- 采用双温度传感器测温，低温段采用K型热电偶控温，高温段采用红外控温；
- 安全性能好：采用HMI+PLC+PID压力传感控制，安全可靠；
- 密封性能好：动态压头均采用波纹管密封，确保不漏气。

Due to the discharge effect caused by the application of DC pulse current during the SPS process, there are several unique characteristics:

- It can quickly heat up and cool down, significantly shorten production time, and reduce production costs (with a heating rate of up to 200°C/min);
- Low sintering temperature (compared to hot pressing sintering, the sintering temperature can be further reduced);
- It has a unique purification and activation effect (Eliminating the adsorption of gas on the surface of powder particles and breaking through the oxide film), easily achieving the sintering of difficult to sinter materials and multi-element materials;
- Compared to traditional sintering processes, materials with more uniform, denser, and smaller grain sizes can be obtained in a shorter time;
- Compared to traditional sintering processes, it can significantly save electricity;
- Adopting our professional DC pulse power supply technology, it has fast sintering speed, stable and reliable performance, and good energy-saving effect; High pressure accuracy: Adopting a servo pressure control system, the pressure accuracy is ±3%;
- Using dual temperature sensors for temperature measurement, K-type thermocouples for temperature control in the low temperature range, and infrared temperature control in the high temperature range;
- Good safety performance: Adopting HMI+PLC+PID pressure sensing control, safe and reliable;
- Good sealing performance: Dynamic pressure heads are sealed with corrugated pipes to ensure no air leakage.

应用领域 / APPLICATIONS

- 金属： Fe、Cu、Al、Au、Ag、Ni、Cr、Mo、Sn、Ti、W、Be；
 - 陶瓷氧化物： Al₂O₃、Mulitex ZrO₂、Mg、SiO₂、TiO、HfO₂；
 - 碳化物： SiC、B₄C、TaC、WC、ZrC、VC；
 - 氮化物： Si₃N₄、TaN、TiN、AlN、ZrN、VN；
 - 硼化物： TiB₂、HfB₂、LaB₆、ZrB₂、VB₂；
 - 氟化物： LiF、CaF₂、MgF₂；
 - 金属陶瓷： Si₃N₄+Ni、Al₂O₃+Ni、ZrO₂+Ni、Al₂O₃+Ti、SUS+WC/Co、BN+Fe、WC+Co+Fe；
 - 金属化合物： TiAl、MoSi₂、Si₃Zr₅、NiAl、NbCo、NbAl、Sm₂Co₁₇。
- Metals: Fe, Cu, Al, Au, Ag, Ni, Cr, Mo, Sn, Ti, W, Be;
 - Ceramic oxides: Al₂O₃, Mulitex ZrO₂, Mg, SiO₂, TiO₂, HfO₂;
 - Carbides: SiC, B₄C, TaC, WC, ZrC, VC;
 - Nitrides: Si₃N₄, TaN, TiN, AlN, ZrN, VN;
 - Boride: TiB₂, HfB₂, LaB₆, ZrB₂, VB₂;
 - Fluorides: LiF, CaF₂, MgF₂;
 - Metal ceramics: Si₃N₄+Ni, Al₂O₃+Ni, ZrO₂+Ni, Al₂O₃+Ti, SUS+WC/Co, BN+Fe, WC+Co+Fe;
 - Metal compounds: TiAl, MoSi₂, Si₃Zr₅, NiAl, NbCo, NbAl, Sm₂Co₁₇.

S6正视图 S6 Front View



产品规格及技术指标 / SPECIFICATIONS & PARAMETERS

产品编号 Numbering	产品型号 Model	有效工作区(mm) Chamber Size (mm)	样品直径(mm) Sample Dia. (mm)	压力(吨) Pressure (ton)	极限真空度(Pa) Ultimate Vacuum (Pa)	工作温度(°C) Operating Temperature (°C)
S6	VHPsp-25/70-2200	Φ250×700	Φ150	100	1	2200
S-200	VHPsp-32/80-2200	Φ320×800	Φ200	200	1	2200
S-300	VHPsp-40/80-2200	Φ400×800	Φ300	250	1	2200
S-400	VHPsp-60/80-2200	Φ600×800	Φ400	400	1	2200

Spark Plasma Sintering System (SPS+Induction)

SPS放电等离子混合烧结系统

S Series

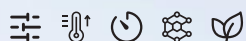

温度均匀性好 / 升温速度快 / 烧结时间短 /
组织结构可控 / 节能环保

Good Temperature Uniformity / Fast Heating Rate /
Short Sintering Time / Controllable Organizational Structure /
Energy-saving and Environmental Protection

S-400D等轴测图

S-400D Isometric View



简介 / BRIEF INTRODUCTION

SPS (Spark Plasma Sintering) 放电等离子烧结系统是当今世界上最先进的烧结系统之一，是在两电极间施加脉冲电流和轴向压力进行粉末烧结致密化的一种新型快速烧结技术。同时使用感应加热作为辅助加热，它具有温度均匀性好、升温速度快、烧结时间短、组织结构可控、节能环保等鲜明特点，可用来制备金属材料、陶瓷材料、复合材料，也可用来制备纳米块体材料、非晶块体材料、梯度材料等。

The SPS (Spark Plasma Sintering)/DCS discharge plasma sintering system is one of the most advanced sintering systems in the world today. It is a new rapid sintering technology that applies pulse current and axial pressure between two electrodes to densify powder sintering. It has distinct characteristics such as fast heating rate, short sintering time, controllable organization structure, energy conservation and environmental protection. It can be used to prepare metal materials, ceramic materials, composite materials, as well as nano bulk materials, amorphous bulk materials, gradient materials, etc..

技术特点 / ADVANTAGES

- 相比于单纯的SPS烧结，增加了感应加热热场，热场温度更加均匀，材料中心和边缘温差缩小，可烧结更大尺寸的产品；
- 生产用的大型SPS系统。充分考量了烧结工艺的自动化和操作性，烧结温度，加压控制，电流控制等自动程控系统为设备的标准配置；
- 配备数据采集解析系统，可将决定烧结体产品品质的工艺参数，如烧结电压、电流、控制温度、施加压力、位移、真空度、位移变化率、实测温度等物理量进行保存和调用，以对产品生产工艺进行追踪；
- 设备采用了自主开发的脉冲变频DC电源，与传统的同等级别SPS相比，耗电量大幅降低，可真正有效地实现节能降耗环保型高品质的烧结生产。
- Compared to pure SPS sintering, it increases the induction heating thermal field, resulting in a more uniform thermal field temperature and a smaller temperature difference between the center and edge of the material, allowing for sintering of larger sized products;
- Large SPS systems used in production. Fully considering the automation and controllability of the sintering process, the standard configuration of the equipment includes automatic program control systems such as sintering temperature, pressure control, and current control;
- Equipped with a data collection and analysis system, it can save and call physical quantities that determine the quality of sintered body products, such as sintering voltage, current, control temperature, applied pressure, displacement, vacuum degree, displacement change rate, measured temperature, etc., to track the production process of the product;
- The equipment adopts a self-developed pulse frequency conversion DC power supply, which significantly reduces power consumption compared to traditional SPS of the same level, and can truly and effectively achieve energy-saving, consumption reducing, and environmentally friendly high-grade sintering production.

产品规格及技术指标 / SPECIFICATIONS & PARAMETERS

产品编号 Numbering	产品型号 Model	有效工作区(mm) Chamber Size (mm)	样品直径(mm) Sample Dia. (mm)	压力(吨) Pressure (ton)	极限真空度(Pa) Ultimate Vacuum (Pa)	工作温度(°C) Operating Temperature (°C)
S-200D	VHPsp-32/80-2200	Φ320×800	Φ200	200	10	2200
S-300D	VHPsp-40/80-2200	Φ400×800	Φ300	250	10	2200
S-400D	VHPsp-60/80-2200	Φ600×800	Φ400	400	10	2200

应用领域 / APPLICATIONS

- 金属: Fe, Cu, Al, Au, Ag, Ni, Cr, Mo, Sn, Ti, W, Be;
- 陶瓷氧化物: Al₂O₃, Mulitex ZrO₂, Mg, SiO₂, TiO, HfO₂;
- 碳化物: SiC, B₄C, TaC, WC, ZrC, VC;
- 氮化物: Si₃N₄, TaN, TiN, AlN, ZrN, VN;
- 硼化物: TiB₂, HfB₂, LaB₆, ZrB₂, VB₂;
- 氟化物: LiF, CaF₂, MgF₂;
- 金属陶瓷: Si₃N₄+Ni, Al₂O₃+Ni, ZrO₂+Ni, Al₂O₃+Ti, SUS+WC/Co, BN+Fe, WC+Co+Fe;
- 金属化合物: TiAl, MoSi₂, Si₃Zr₅, NiAl, NbCo, NbAl, Sm₂Co₇.
- Metals: Fe, Cu, Al, Au, Ag, Ni, Cr, Mo, Sn, Ti, W, Be;
- Ceramic oxides: Al₂O₃, Mulitex ZrO₂, Mg, SiO₂, TiO₂, HfO₂;
- Carbides: SiC, B₄C, TaC, WC, ZrC, VC;
- Nitrides: Si₃N₄, TaN, TiN, AlN, ZrN, VN;
- Boride: TiB₂, HfB₂, LaB₆, ZrB₂, VB₂;
- Fluorides: LiF, CaF₂, MgF₂;
- Metal ceramics: Si₃N₄+Ni, Al₂O₃+Ni, ZrO₂+Ni, Al₂O₃+Ti, SUS+WC/Co, BN+Fe, WC+Co+Fe;
- Metal compounds: TiAl, MoSi₂, Si₃Zr₅, NiAl, NbCo, NbAl, Sm₂Co₇.

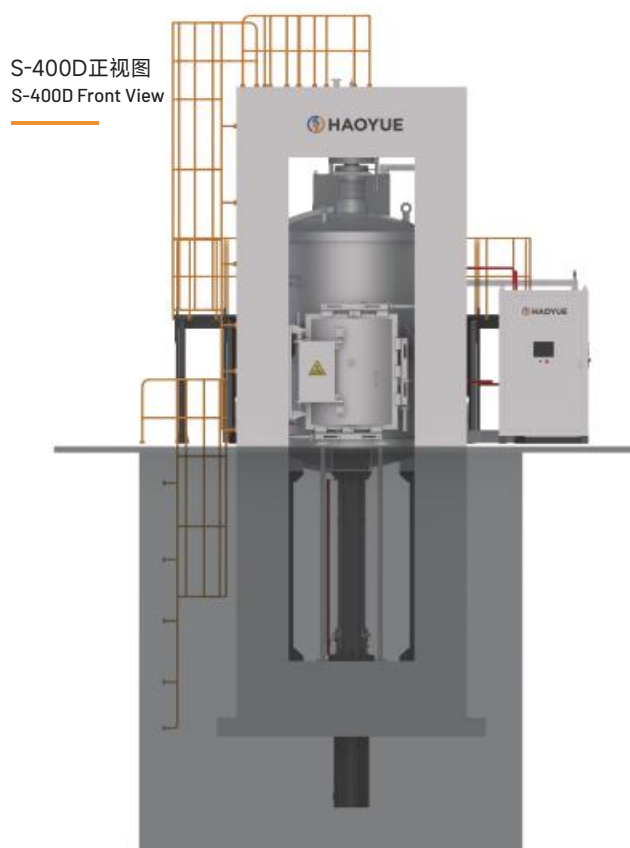

Semi-continuous Type Spark Plasma Sintering

SPS半连续式等离子烧结系统

S Series

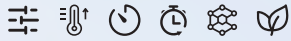

温度均匀性好 / 升温速度快 / 烧结时间短 / 生产效率高 /
组织结构可控 / 节能环保

Good Temperature Uniformity / Fast Heating Rate / Short Sintering Time /
High Production Efficiency / Controllable Organizational Structure /
Energy-saving and Environmental Protection

简介 / BRIEF INTRODUCTION

SPS(Spark Plasma Sintering)放电等离子烧结系统是当今世界上最先进的烧结系统之一，是在两电极间施加脉冲电流和轴向压力进行粉末烧结致密化的一种新型快速烧结技术。它具有升温速度快、烧结时间短、组织结构可控、节能环保等鲜明特点，可用于制备金属材料、陶瓷材料、复合材料，也可用来制备纳米块体材料、非晶块体材料、梯度材料等。半连续式成产，可增加生产效率。

The SPS (Spark Plasma Sintering) DCS discharge plasma sintering system is one of the most advanced sintering systems in the world today. It is a new rapid sintering technology that applies pulse current and axial pressure between two electrodes to densify powder sintering. It has distinct characteristics such as fast heating rate, short sintering time, controllable organizational structure, energy conservation and environmental protection. It can be used to prepare metal materials, ceramic materials, composite materials, as well as nano bulk materials, amorphous bulk materials, gradient materials, etc. Semi continuous production can increase production efficiency.

S6S等轴测图

S6S Isometric View

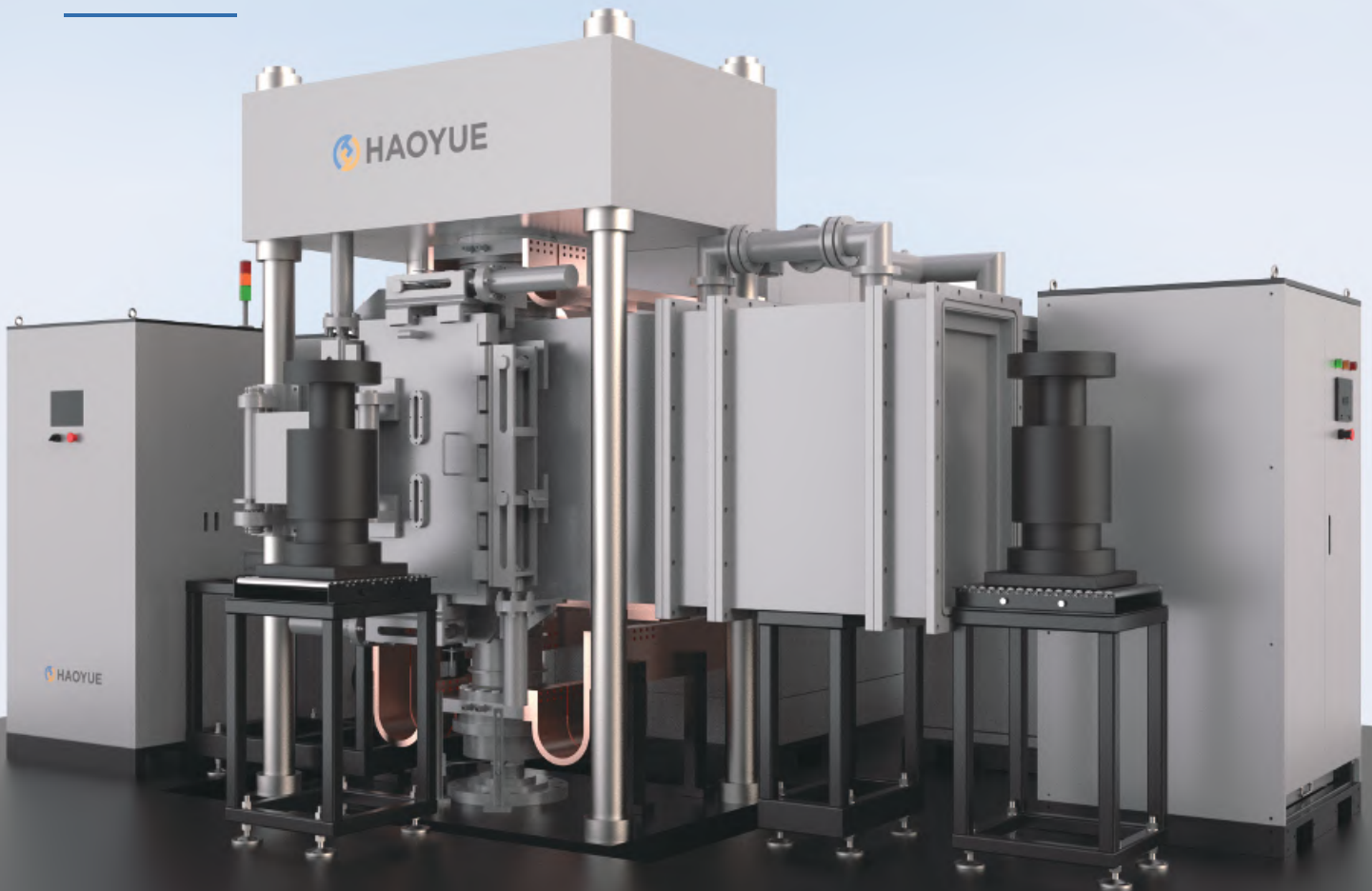

技术特点 / ADVANTAGES

由于SPS过程中施加直流脉冲电流产生放电效应而带来的一些特有现象，有以下几个特点：

- 半连续式设计：设计为加热室和冷却室共2个腔室，较连续式SPS可减少设备成本，可使得效率增加，产量提升。
- 可以快速升温，快速冷却，大幅缩短生产时间，降低生产成本(升温速率可达200°C/min)；
- 具有独特的净化、活化效应(消除粉末颗粒表面吸附气体，击穿氧化膜)，轻松实现难烧结材料、多元素材料的烧结；
- 相比于传统烧结工艺，可以在更短的时间内得到组织性质更均匀、更致密、晶粒尺寸更小的材料；
- 相比于传统烧结工艺，可大幅节省电能；
- 采用我司专业直流脉冲电源技术，具有烧结速度快、稳定可靠，节能效果好；
- 压力精度高：采用伺服压力控制系统，压力精度为±3‰；
- 采用双红外测温，一红外控温，另一个红外测温或校准温度；
- 安全性性能好：采用HMI+PLC+PID压力传感控制，安全可靠；
- 密封性能好：动态压头均采用波纹管密封，确保不漏气。

Due to the discharge effect caused by the application of DC pulse current during the SPS process, some unique phenomena occur, There are several characteristics:

- Semi continuous design: designed with a total of 2 chambers for heating and cooling, compared to continuous SPS, it can reduce equipment costs, increase efficiency, and increase production.
- It can quickly heat up and cool down, significantly shorten production time, and reduce production costs (with a heating rate of up to 200°C/min);
- It has a unique purification and activation effect (eliminating the adsorption of gas on the surface of powder particles and breaking through the oxide film), easily achieving the sintering of difficult to sinter materials and multi-element materials;
- Compared to traditional sintering processes, materials with more uniform, denser, and smaller grain sizes can be obtained in a shorter time;
- Compared to traditional sintering processes, it can significantly save electricity;
- Adopting our professional DC pulse power supply technology, it has fast sintering speed, stable and reliable performance, and good energy-saving effect;
- High pressure accuracy: Adopting a servo pressure control system, the pressure accuracy is ±3‰;
- Adopting dual infrared temperature measurement, with one infrared temperature control and the other infrared temperature measurement or calibration;
- Good safety performance: Adopting HMI+PLC+PID pressure sensing control, safe and reliable;
- Good sealing performance: The dynamic pressure heads are sealed with corrugated pipes to ensure no air leakage.

应用领域 / APPLICATIONS

- 金属： Fe、Cu、Al、Au、Ag、Ni、Cr、Mo、Sn、Ti、W、Be；
 - 陶瓷氧化物： Al₂O₃、Mulitex ZrO₂、Mg、SiO₂、TiO、HfO₂；
 - 碳化物： SiC、B₄C、TaC、WC、ZrC、VC；
 - 氮化物： Si₃N₄、TaN、TiN、AlN、ZrN、VN；
 - 硼化物： TiB₂、HfB₂、LaB₆、ZrB₂、VB₂；
 - 氟化物： LiF、CaF₂、MgF₂；
 - 金属陶瓷： Si₃N₄+Ni、Al₂O₃+Ni、ZrO₂+Ni、Al₂O₃+Ti、SUS+WC/Co、BN+Fe、WC+Co+Fe；
 - 金属化合物： TiAl、MoSi₂、Si₃Zr₅、NiAl、NbCo、NbAl、Sm₂Co₁₇。
- Metals: Fe, Cu, Al, Au, Ag, Ni, Cr, Mo, Sn, Ti, W, Be;
 - Ceramic oxides: Al₂O₃, Mulitex ZrO₂, Mg, SiO₂, TiO₂, HfO₂;
 - Carbides: SiC, B₄C, TaC, WC, ZrC, VC;
 - Nitrides: Si₃N₄, TaN, TiN, AlN, ZrN, VN;
 - Boride: TiB₂, HfB₂, LaB₆, ZrB₂, VB₂;
 - Fluorides: LiF, CaF₂, MgF₂;
 - Metal ceramics: Si₃N₄+Ni, Al₂O₃+Ni, ZrO₂+Ni, Al₂O₃+Ti, SUS+WC/Co, BN+Fe, WC+Co+Fe;
 - Metal compounds: TiAl, MoSi₂, Si₃Zr₅, NiAl, NbCo, NbAl, Sm₂Co₁₇.

S6S正视图
S6S Front View



产品规格及技术指标 / SPECIFICATIONS & PARAMETERS

产品编号 Numbering	产品型号 Model	设备工作形式 Device form	样品直径(mm) Sample Dia. (mm)	压力(吨) Pressure (ton)	极限真空度(Pa) Ultimate Vacuum (Pa)	工作温度(°C) Operating Temperature (°C)
S6S	VSPsp-25/70-2200	半连续式(双室) Semi-continuous (Two chamber)	Φ150	100	10	2200
S-200S	VSPsp-32/80-2200	半连续式(双室) Semi-continuous (Two chamber)	Φ200	200	10	2200

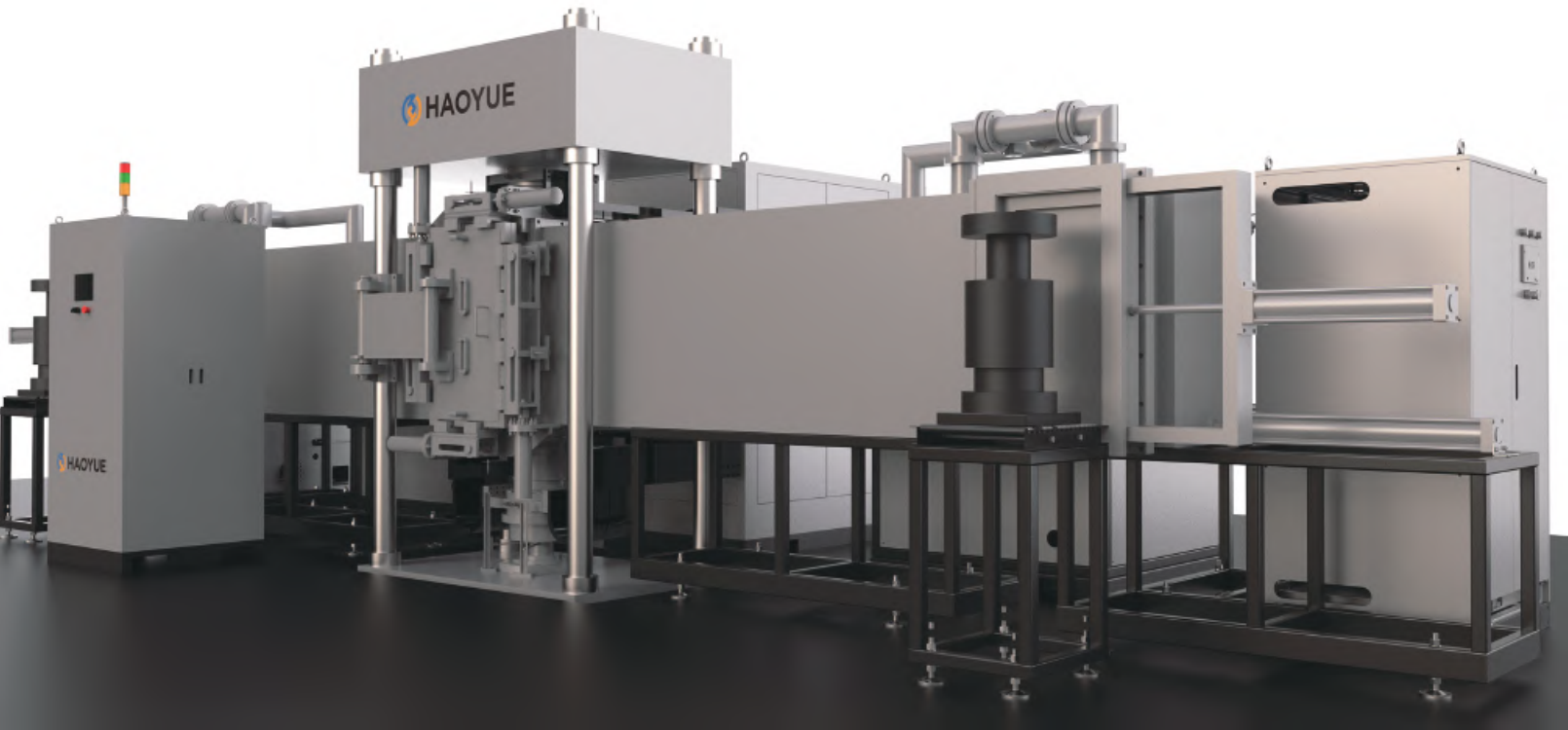

Continuous SPS Plasma Sintering Furnace

SPS连续式放电等离子烧结系统

S Series

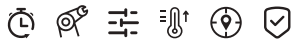

生产效率高 / 自动化程序高 / 温度均匀性好 / 升温速度快 /
压力精度高 / 安全性能好

High Production Efficiency / High Automation Program / Good Temperature
Uniformity / Fast Heating Speed / High Pressure Accuracy / Good Safety
Performance

简介 / BRIEF INTRODUCTION

SPS(Spark Plasma Sintering)放电等离子烧结系统是当今世界上最先进的烧结系统之一，是在两电极间施加脉冲电流和轴向压力进行粉末烧结致密化的一种新型快速烧结技术。它具有升温速度快、烧结时间短、组织结构可控、节能环保等鲜明特点，可用于制备金属材料、陶瓷材料、复合材料，也可用来制备纳米块体材料、非晶块体材料、梯度材料等。

The SPS(Spark Plasma Sintering) discharge plasma sintering system is one of the most advanced sintering systems in the world today. It is a new rapid sintering technology that applies pulse current and axial pressure between two electrodes for powder sintering densification. It has distinct characteristics such as fast heating rate, short sintering time, controllable microstructure, energy conservation and environmental protection. It can be used to prepare metal materials, ceramic materials, composite materials, as well as nano bulk materials, amorphous bulk materials, gradient materials, etc..

技术特点 / ADVANTAGES

由于SPS过程中施加直流脉冲电流产生放电效应而带来的一些特有现象，有以下几个特点：

- 采用多工位设计，可以连续生产，使得效率倍增。
- 可以快速升温，快速冷却，大幅缩短生产时间，降低生产成本(升温速率可达200°C/min)；
- 相比于传统烧结工艺，可以在更短的时间内得到组织性质更均匀、更致密、晶粒尺寸更小的材料；
- 无需粉末预成型，可以直接烧结成致密体；
- 采用我司专业直流脉冲电源技术，具有烧结速度快、稳定可靠，节能效果好；
- 压力精度高：采用伺服压力控制系统，压力精度为±3%；
- 自动化程度高：如选装自动装卸料系统，将可完成所有工序全自动运行，数字化、智能化、无需人工干预；
- 安全性性能好：采用HMI+PLC+PID压力传感控制，安全可靠；
- 密封性能好：动态压头均采用波纹管密封，确保不漏气。

Due to the discharge effect caused by the application of DC pulse current during the SPS process, there are several unique characteristics:

- By adopting a multi station design, continuous production can be achieved, resulting in a doubling of efficiency.
- It can quickly heat up and cool down, significantly shorten production time, and reduce production costs (with a heating rate of up to 200°C/min);
- Compared to traditional sintering processes, materials with more uniform, denser, and smaller grain sizes can be obtained in a shorter time;
- No need for powder preforming, it can be directly sintered into a dense body;
- We adopt our professional DC pulse power supply technology, which has fast sintering speed, stability and reliability, and good energy-saving effect;
- High pressure accuracy: Adopting a servo pressure control system, the pressure accuracy is ±3%;
- High degree of automation: If an automatic loading and unloading system is selected, all processes can be fully automated, digitized, intelligent, and without the need for manual intervention;
- Good safety performance: Adopting HMI+PLC+PID pressure sensing control, safe and reliable;
- Good sealing performance: The dynamic pressure heads are sealed with corrugated pipes to ensure no air leakage.

产品规格及技术指标 / SPECIFICATIONS & PARAMETERS

产品编号 Numbering	产品型号 Model	设备工作形式 Device form	样品直径(mm) Sample Dia. (mm)	压力(吨) Pressure (Ton)	冷态极限真空度(Pa) Ultimate Vacuum (Pa)	工作温度(°C) Operating Temperature (°C)
S6C	VCPsp-25/70-2200	连续式 Continuous	Φ150	100	1	2200
S-200C	VCPsp-32/80-2200	连续式 Continuous	Φ200	200	1	2200

S6C-透视图

S6C Perspective View

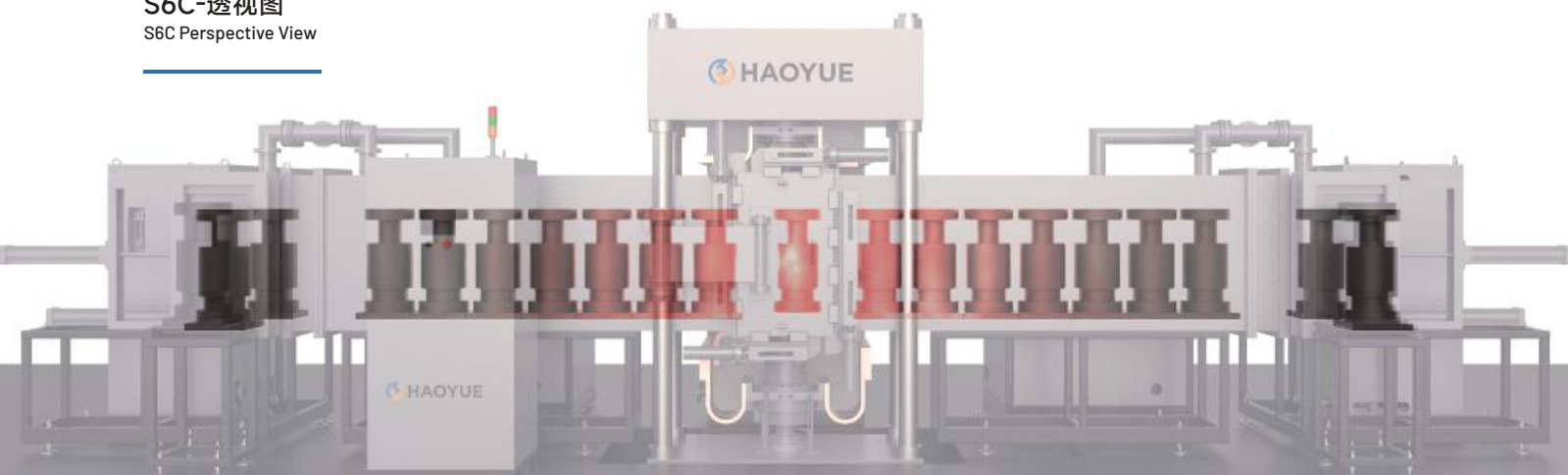

应用领域 / APPLICATIONS

- 金属： Fe、Cu、Al、Au、Ag、Ni、Cr、Mo、Sn、Ti、W、Be；
 - 陶瓷氧化物： Al₂O₃、Mulitex ZrO₂、Mg、SiO₂、TiO₂、HfO₂；
 - 碳化物： SiC、B₄C、TaC、WC、ZrC、VC；
 - 氮化物： Si₃N₄、TaN、TiN、AlN、ZrN、VN；
 - 硼化物： TiB₂、HfB₂、LaB₆、ZrB₂、VB₂；
 - 氟化物： LiF、CaF₂、MgF₂；
 - 金属陶瓷： Si₃N₄+Ni、Al₂O₃+Ni、ZrO₂+Ni、Al₂O₃+Ti、SUS+WC/Co、BN+Fe、WC+Co+Fe；
 - 金属化合物： TiAl、MoSi₂、Si₃Zr₅、NiAl、NbCo、NbAl、Sm₂Co₁₇。
- Metals: Fe, Cu, Al, Au, Ag, Ni, Cr, Mo, Sn, Ti, W, Be;
 - Ceramic oxides: Al₂O₃, Mulitex ZrO₂, Mg, SiO₂, TiO₂, HfO₂;
 - Carbides: SiC, B₄C, TaC, WC, ZrC, VC;
 - Nitrides: Si₃N₄, TaN, TiN, AlN, ZrN, VN;
 - Boride: TiB₂, HfB₂, LaB₆, ZrB₂, VB₂;
 - Fluorides: LiF, CaF₂, MgF₂;
 - Metal ceramics: Si₃N₄+Ni, Al₂O₃+Ni, ZrO₂+Ni, Al₂O₃+Ti, SUS+WC/Co, BN+Fe, WC+Co+Fe;
 - Metal compounds: TiAl, MoSi₂, Si₃Zr₅, NiAl, NbCo, NbAl, Sm₂Co₁₇.

Vacuum Hot Pressing Furnace (Graphite)

真空热压炉(石墨加热)

P Series

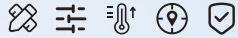

设计优化好 / 温度均匀性好 / 升温速度快 / 压力精度高 / 安全性能好

Good Design Optimization / Temperature Uniformity / Fast Heating Speed /
High Pressure Accuracy / Good Safety Performance

简介 / BRIEF INTRODUCTION

真空热压炉是在真空（或其它气氛）条件下将材料热压成型的成套设备，主要采用石墨电阻式加热，由油缸驱动的压头上下加压。在高温下，物料生坯固体颗粒的相互键联，晶粒长大，空隙（气孔）和晶界渐趋减少，通过物质的传递，其总体积收缩，密度增加，最后成为具有某种显微结构的致密多晶烧结体，从而将物料压制成形。

A vacuum hot pressing furnace is a complete set of equipment that forms materials by hot pressing under vacuum (or other atmosphere) conditions, Mainly using graphite resistance heating, the pressure head driven by the oil cylinder pressurizes up and down. At high temperatures The mutual bonding of solid particles in raw materials leads to grain growth, and the number of voids (pores) and grain boundaries gradually decreases, Through the transfer of matter, its total volume shrinks, density increases, and eventually becomes a microstructure with some kind of microstructure Construct a dense polycrystalline sintered body, thereby compressing the material into shape.

P7VGR22等轴测图

P7VGR22 Isometric View



技术特点 / ADVANTAGES

- 采用立式、侧开门结构：装、卸模具精度高，操作方便；
 - 升温快：升温速率10°C/分钟(≤1600°C)，升温速率5°C/分钟(>1600°C)；
 - 设计优化好：加压室热场经热态模拟计算，具有非常高的温度均匀性、配置的加热元件及隔热层采用模块化优化设计；
 - 温度均匀性好：平均温度均匀性为±5°C(5点测温，恒温区1000°C保温1h后检测)；
 - 压力精度高：采用液压控制系统，压力精度为≤±3‰；
 - 采用多温区控制：预留多个测温孔，以便高温监测使用；
 - 安全性能好：采用HMI+PLC+PID压力传感控制，安全可靠；
 - 密封性能好：动态压头均采用波纹管密封，确保不漏气；
 - 自动化程度高：除装料卸料外，其它所有工序全自动运行，数字化、智能化、无需人工干预；
 - 冷却速度快：可选配2bar气体压力下外循环快速冷却系统，保证工件热压完毕快速冷却，高效运行。
- Adopting a vertical and side opening door structure: high precision in mold loading and unloading, easy to operate;
 - Fast heating: heating rate of 10°C/minute(≤1600°C), heating rate of 5°C/minute(>1600°C);
 - Good design optimization: The thermal field of the pressurized chamber has been simulated and calculated in thermal state, with very high temperature uniformity. The configured heating elements and insulation layer are designed with modular optimization;
 - Good temperature uniformity: The average temperature uniformity is ±5°C (5-point temperature measurement, constant temperature zone 1000°C insulation for 1 hour before detection);
 - High pressure accuracy: using a hydraulic control system, the pressure accuracy is ≤±3‰;
 - Adopting multi temperature zone control: reserving multiple temperature measurement holes for high-temperature monitoring purposes;
 - Good safety performance: Adopting HMI+PLC+PID pressure sensing control, safe and reliable;
 - Good sealing performance: The dynamic pressure heads are sealed with corrugated pipes to ensure no air leakage;
 - High degree of automation: Except for loading and unloading, all other processes are fully automated, digitized, intelligent, and do not require manual intervention;
 - Fast cooling speed: Optional external circulation fast cooling system under a gas pressure of 2 bar, ensuring fast cooling and efficient operation of the workpiece after hot pressing.

应用领域 / APPLICATIONS

真空热压炉广泛应用于各类复合材料、各类高导热材料、氧化铌/碳化硅/碳化硼/氮化硼或陶瓷类材料、铜基粉末材料、铁基粉末材料、铁铜基粉末材料等材料的零件净近成型、致密化处理。诸如：飞机降落铁铜基粉末材料刹车盘、防弹衣、装甲车护板、直升飞机防弹装甲等。

Vacuum hot pressing furnaces are widely used in various composite materials, high thermal conductivity materials, niobium oxide/silicon carbide/boron carbide/nitrogen. Parts of boron or ceramic materials, copper based powder materials, iron based powder materials, iron copper based powder materials, and other materials. Net shaping and densification treatment.

For example: brake discs made of iron and copper based powder materials for aircraft landing, bulletproof vests, armored vehicle shields, helicopter bulletproof armor, etc.

P7VGR22俯视图
P7VGR22 Vertical View

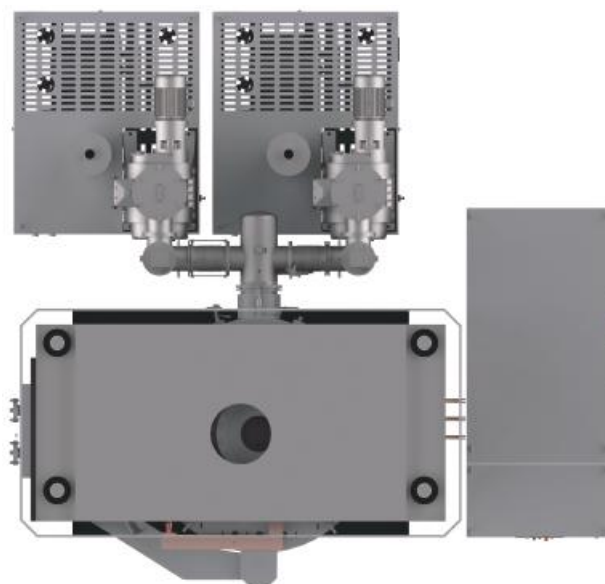

产品规格及技术指标 / SPECIFICATIONS & PARAMETERS

产品编号 Numbering	产品型号 Model	最大模套外径(mm) Chamber Size (mm)	样品直径(mm) Sample Dia. (mm)	压力(吨) Pressure (ton)	压头行程(mm) Stroke (mm)	冷态极限真空度(Pa) Ultimate Vacuum (Pa)	工作温度(°C) Operating Temperature (°C)	CFC模套物料 最大直径(mm) Max. Diameter of mold (mm)
P3VGR22	VVPgr-30/30-2200	Φ300×300	Φ120	60	150	5/6.7×10 ⁻³	2200	180
P4VGR22	VVPgr-40/40-2200	Φ400×400	Φ200	200	200	5/6.7×10 ⁻³	2200	240
P5VGR22	VVPgr-50/50-2200	Φ500×500	Φ250	300	200	5/6.7×10 ⁻³	2200	300
P7VGR22	VVPgr-70/70-2200	Φ700×700	Φ420	600	350	5/6.7×10 ⁻³	2200	450
P8VGR22	VVPgr-80/80-2200	Φ800×800	Φ450	800	400	5/6.7×10 ⁻³	2200	500
P10VGR22	VVPgr-100/100-2200	Φ1000×1000	Φ600	1500	500	5/6.7×10 ⁻³	2200	650

Vacuum Hot Pressing Furnace (Induction)

真空热压炉(感应加热)

P Series



生产效率高 / 温度均匀性好 / 升温速度快 / 压力精度高 / 安全性能好

Good Design Optimization / Temperature Uniformity / Fast Heating Speed /
High Pressure Accuracy / Good Safety Performance

简介 / BRIEF INTRODUCTION

真空热压炉是在真空（或其它气氛）条件下将材料热压成型的成套设备，主要采用感应加热，由油缸驱动的压头上下加压。在高温下，物料生坯固体颗粒的相互键联，晶粒长大，空隙（气孔）和晶界渐趋减少，通过物质的传递，其总体积收缩，密度增加，最后成为具有某种显微结构的致密多晶烧结体，从而将物料压制成形。

A vacuum hot pressing furnace is a complete set of equipment that forms materials by hot pressing under vacuum (or other atmosphere) conditions, mainly using induction heating, the pressure head driven by the oil cylinder pressurizes up and down. At high temperatures, the raw material. The mutual bonding of solid particles leads to grain growth, and the number of voids (pores) and grain boundaries gradually decreases. The transfer of matter results in a total volume contraction, an increase in density, and ultimately becomes a material with a certain microstructure, Dense polycrystalline sintered body, thereby compressing the material into shape.

P7VCO23-III等轴测图

P7VCO23-III Isometric Drawings



P7VC023-III正视图
P7VC023-III Front View



技术特点 / ADVANTAGES

- 采用立式、上开门结构：装、卸模具精度高，操作方便；
 - 升温快：升温速率20°C/分钟(<1600°C)，升温速率10°C/分钟(>1600°C)；
 - 设计优化好：加压室热场经热态模拟计算，具有非常高的温度均匀性、配置的加热元件及隔热层采用模块化优化设计；
 - 温度均匀性好：平均温度均匀性为±5°C(5点测温，恒温区1000°C保温1h后检测)；
 - 压力精度高：采用液压控制系统，压力精度为≤±3%；
 - 采用多温区控制：预留多个测温孔，以便高温监测使用；
 - 安全性能好：采用HMI+PLC+PID压力传感控制，安全可靠；
 - 密封性能好：动态压头均采用波纹管密封，确保不漏气；
 - 自动化程度高：除装料卸料外，其它所有工序全自动运行，数字化、智能化、无需人工干预。
- Adopting a vertical and upward opening structure: high precision for loading and unloading molds, easy to operate;
 - Fast heating: heating rate of 20°C/minute (<1600°C), heating rate of 10°C/minute (>1600°C);
 - Design optimization is good: The thermal field of the pressurized chamber has been simulated and calculated under thermal conditions, with very high temperature uniformity and compatibility. The heating elements and insulation layer are designed with modular optimization;
 - Good temperature uniformity: The average temperature uniformity is ±5°C (measured at 5 points, with a constant temperature zone of 1000°C for 1 hour before testing);
 - High pressure accuracy: Using a hydraulic control system, the pressure accuracy is ≤ ±3%;
 - Adopting multi temperature zone control: reserving multiple temperature measurement holes for high-temperature monitoring purposes;
 - Good safety performance: Adopting HMI+PLC+PID pressure sensing control, safe and reliable;
 - Good sealing performance: The dynamic pressure heads are sealed with corrugated pipes to ensure no air leakage;
 - High degree of automation: Except for loading and unloading, all other processes are fully automated, digitized, intelligent, and do not require manual intervention.

应用领域 / APPLICATIONS

适用于氧化铌、碳化硅、碳化硼、氮化硼等陶瓷材料或石墨烯碳纤维、高温合金金属粉末材料的高温高压烧结成形及增密粉末冶金、功能陶瓷等新材料的高温热成型，也可用于粉末或压坯在低于主要组分熔点的温度下的热处理，目的在于通过颗粒间的冶金结合以提高其强度。

诸如：飞机降落铁铜基粉类材料刹车盘、防弹衣、装甲车护板、直升飞机防弹装甲等。

Suitable for ceramic materials such as niobium oxide, silicon carbide, boron carbide, boron nitride, or graphene carbon. High temperature pressure sintering and densification powder metallurgy of fiber and high-temperature alloy metal powder materials. High temperature hot forming of new materials such as gold and functional ceramics can also be used for powder or compact at low temperatures. Heat treatment at the melting point of the main components, with the aim of achieving metallurgical properties between particles combine to enhance its strength.

For example: brake discs made of iron and copper based powder materials for aircraft landing, bulletproof vests, armored vehicle protective plates, and straight upgrade aircraft's bulletproof armor, etc.

产品规格及技术指标 / SPECIFICATIONS & PARAMETERS

产品编号 Numbering	产品型号 Model	最大模套外径(mm) Chamber Size (mm)	产品尺寸(mm) Sample Dia. (mm)	压力(吨) Pressure (ton)	产能 Capacity	真空度(Pa) Ultimate Vacuum (Pa)	工作温度(°C) Operating Temperature (°C)	备注 Note
P7VC023	VVPco-70/70-2300	Φ700×700	300×250/Φ420	500/600	12×1	6.7×10 ⁻³	2300	单机 Single
P7VC023-II	VVPco-70/70-2300-II	Φ700×700	300×250/Φ420	500/600	12×2	6.7×10 ⁻³	2300	一拖二 One for two
P7VC023-III	VVPco-70/70-2300-III	Φ700×700	300×250/Φ420	500/600	12×3	6.7×10 ⁻³	2300	一拖三 One for three

P7CGR22正视图
P7CGR22 Front View

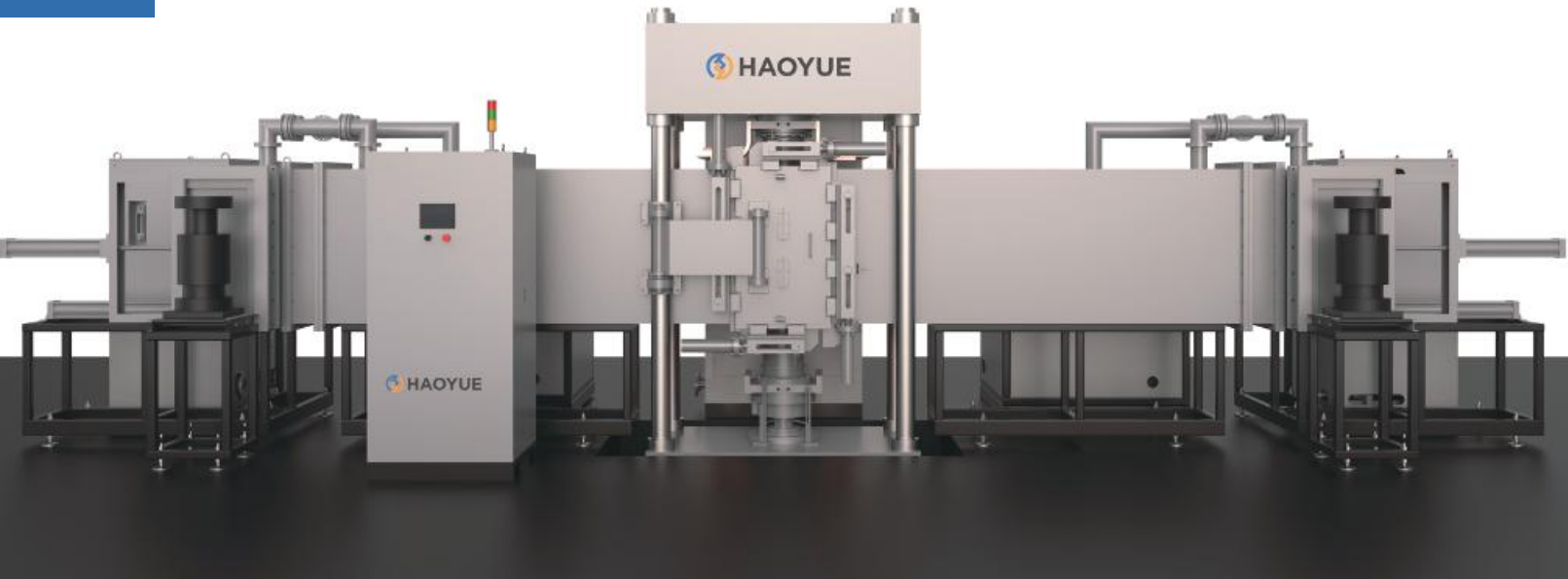

Continuous Hot Press Furnace (Graphite) P Series

连续式热压炉(石墨加热)

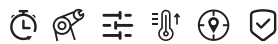

生产效率高 / 自动化程度高 / 温度均匀性好 / 升温速度快 /
压力精度高 / 安全性能好

Good Design Optimization / Temperature Uniformity / Fast Heating Speed /
High Pressure Accuracy / Good Safety Performance



简介 / BRIEF INTRODUCTION

连续式真空热压炉是在真空（或其它气氛）条件下将材料热压成型的连续式成套设备，主要采用石墨电阻式加热，由油缸驱动的压头上下加压。在高温下，物料生坯固体颗粒的相互键联，晶粒长大，空隙（气孔）和晶界渐趋减少，通过物质的传递，其总体积收缩，密度增加，最后成为具有某种显微结构的致密多晶烧结体，从而将物料压制成形。

连续式真空热压设备具有先进、生产自动化程度高、处理量大、热压产品质量好等优点。可大大提高企业的生产效率，节约人工成本。

Continuous vacuum hot pressing furnace is a process of forming materials by hot pressing them under vacuum (or other atmosphere) conditions. The continuous complete set of equipment mainly adopts graphite resistance heating and a pressure head driven by oil cylinders. Apply pressure up and down. At high temperatures, the mutual bonding of solid particles in raw materials leads to grain growth. Voids (pores) and grain boundaries gradually decrease, and their total volume shrinks through material transfer. The density increases and eventually becomes a dense polycrystalline sintered body with a certain microstructure, thereby, material compression forming.

Continuous vacuum hot pressing equipment has the advantages of advanced technology, high degree of production automation, large processing capacity, and thermal stability. Advantages such as good product quality. Can greatly improve the production efficiency of enterprises and save labor costs.

P7CGR22等轴透视图

P7CGR22 Isometric Perspective View

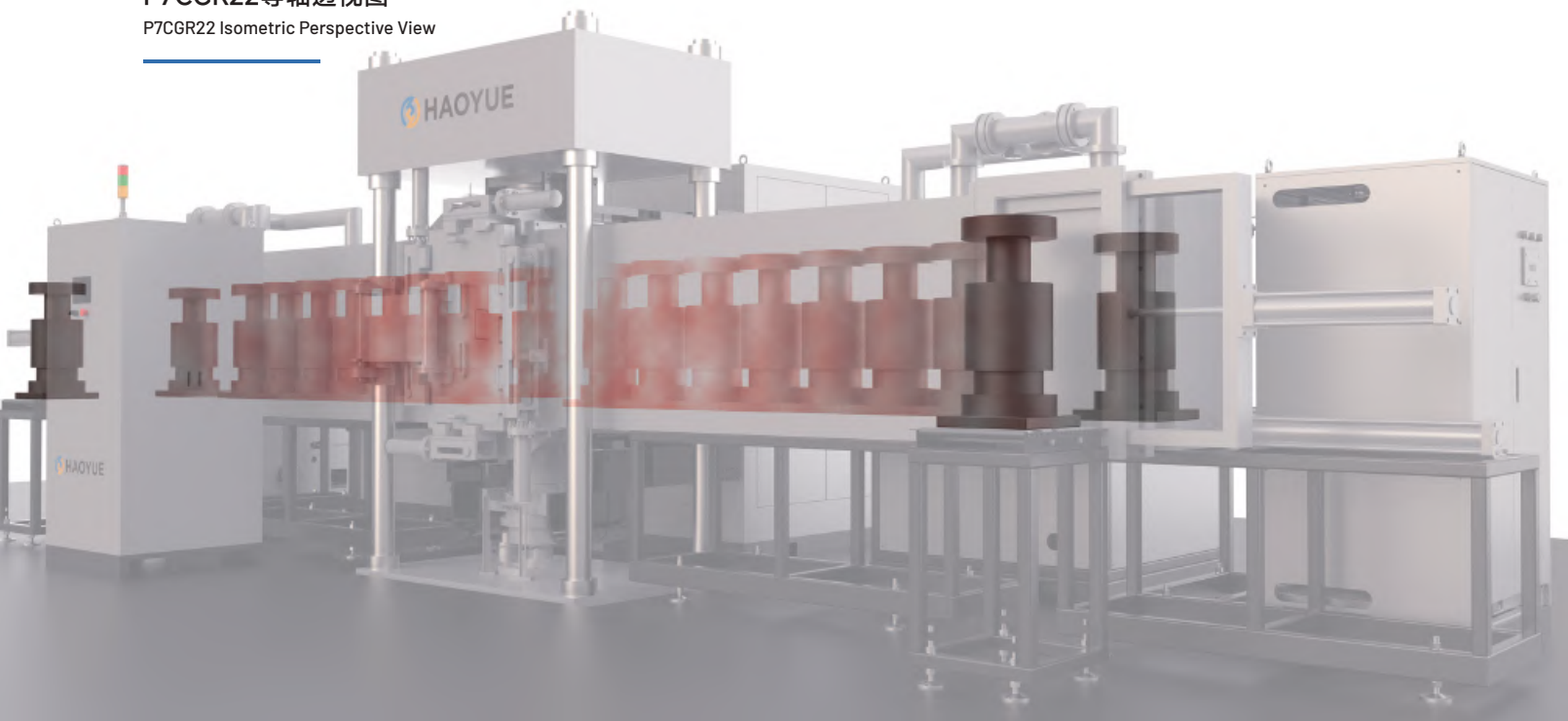

技术特点 / ADVANTAGES

- 采用多工位设计，可以连续生产，使得效率倍增；
 - 升温快：升温速率10°C/分钟(≤1600°C)，升温速率5°C/分钟(>1600°C)；
 - 设计优化好：加压室热场经热态模拟计算，具有非常高的温度均匀性、配置的加热元件及隔热层采用模块化优化设计；
 - 温度均匀性好：平均温度均匀性为±5°C(5点测温，恒温区1000°C保温1h后检测)；
 - 压力精度高：采用液压控制系统，压力精度为≤±3‰；
 - 采用多温区控制：预留多个测温孔，以便高温监测使用；
 - 安全性能好：采用HMI+PLC+PID压力传感控制，安全可靠；
 - 密封性能好：动态压头均采用波纹管密封，确保不漏气；
 - 自动化程度高：如选装自动装卸料系统，将可完全实现所有工序全自动运行，数字化、智能化、无需人工干预。
- Adopting a multi station design, continuous production can be achieved, resulting in doubled efficiency;
 - **Fast heating:** heating rate of 10°C/minute (≤1600°C), heating rate of 5°C/minute (>1600°C);
 - **Good design optimization:** The thermal field of the pressurized chamber has been simulated and calculated in thermal state, with very high temperature uniformity. The configured heating elements and insulation layer are designed with modular optimization;
 - **Good temperature uniformity:** The average temperature uniformity is ±5°C (5-point temperature measurement, constant temperature zone 1000°C insulation for 1 hour before detection);
 - **High pressure accuracy:** using a hydraulic control system, the pressure accuracy is ≤±3‰;
 - **Adopting multi temperature zone control:** reserving multiple temperature measurement holes for high-temperature monitoring purposes;
 - **Good safety performance:** Adopting HMI+PLC+PID pressure sensing control, safe and reliable;
 - **Good sealing performance:** The dynamic pressure heads are sealed with corrugated pipes to ensure no air leakage;
 - **High degree of automation:** If an automatic loading and unloading system is selected, all processes can be fully automated, digitized, intelligent, and without the need for manual intervention.

应用领域 / APPLICATIONS

适用于氧化铌、碳化硅、碳化硼、氮化硼等陶瓷材料或石墨烯碳纤维、高温合金金属粉末材料的高温高压烧结成形及增密粉末冶金、功能陶瓷等新材料的高温热成型，也可用于粉末或压坯在低于主要组分熔点的温度下的热处理，目的在于通过颗粒间的冶金结合以提高其强度。

Suitable for ceramic materials such as niobium oxide, silicon carbide, boron carbide, boron nitride, or graphene carbon fiber, High temperature pressure sintering and densification of high-temperature alloy metal powder materials, as well as new developments in powder metallurgy, functional ceramics, etc. High temperature hot forming of materials can also be used for powder or compact materials at temperatures below the melting point of the main components. Heat treatment aims to improve its strength through metallurgical bonding between particles.

产品规格及技术指标 / SPECIFICATIONS & PARAMETERS

产品编号 Numbering	产品型号 Model	最大模套外径(mm) Chamber Size (mm)	设备形式 Device Form	样品直径(mm) Sample Dia. (mm)	压力(吨) Pressure(ton)	冷态极限真空度(Pa) Ultimate Vacuum (Pa)	工作温度(°C) Operating Temperature (°C)
P7CGR22	VCPgr-70/70-2200	Φ700×700	连续式 Continuous	Φ420	600	10	2200
P10CGR22	VCPgr-100/100-2200	Φ1000×1000	连续式 Continuous	Φ600	1500	10	2200

Vacuum Furnace(Graphite)

真空炉(石墨加热)

V Series



稳定性好 / 温度均匀性好 / 升温速度快 / 安全性能好 / 冷却速度快

Good Design Optimization / Temperature Uniformity / Fast Heating Speed /
High Pressure Accuracy / Good Safety Performance

简介 / BRIEF INTRODUCTION

该真空炉是用石墨作发热元件的真空电阻炉，主要应用于陶瓷、硬质合金、复合材料等在真空或保护气氛中高温烧结或退火等热处理，也可以供金属材料在高真空条件下的高温热处理或贵金属材料的除气处理。

This vacuum furnace is a vacuum resistance furnace that uses graphite as a heating element, mainly used in ceramics, hard alloys. Composite materials can also be used for heat treatment such as high-temperature sintering or annealing in vacuum or protective atmosphere, as well as for metal materials. High temperature heat treatment of materials under high vacuum conditions or degassing treatment of precious metal materials.

V10GR23等轴测图

V10GR23 Isometric View



技术特点 / ADVANTAGES

- 采用卧式、侧开门结构：装卸物料，操作方便；
 - 升温快：升温速率10°C/分钟(≤1600°C)，升温速率5°C/分钟(>1600°C)；
 - 设计优化好：加热室热场经热态模拟计算，具有非常高的温度均匀性、配置的加热元件及隔热层采用模块化优化设计；
 - 采用多温区控制：预留多个测温孔，以便高温监测使用；
 - 温度均匀性好：平均温度均匀性为±5°C（5点测温，恒温区1000°C保温1h后检测）；
 - 冷却速度快：可选配2bar-10bar气体压力下快速冷却系统，保证工件热压完毕快速冷却，高效运行；
 - 稳定性好：设备长时间运行稳定，故障率非常低；
 - 安全性好：采用HMI+PLC+PID压力传感控制，安全可靠；
 - 可拓展性强：可烧结、退火、脱脂、除气等。
- **Adopting a horizontal and side door structure:** Loading and unloading materials, easy to operate;
 - **Fast heating:** Heating rate of 10°C/minute (≤1600°C), heating rate of 5°C/minute (>1600°C);
 - **Good design optimization:** The heating chamber's thermal field has been simulated and calculated under thermal conditions, with very high temperature uniformity and compatibility. The heating elements and insulation layer are designed with modular optimization;
 - **Adopting multi temperature zone control:** Reserving multiple temperature measurement holes for high-temperature monitoring purposes;
 - **Good temperature uniformity:** The average temperature uniformity is ±5°C (5-point temperature measurement, constant temperature zone 1000°C insulation for 1 hour before detection);
 - **Fast cooling speed:** Optional with a fast cooling system under a gas pressure of 2 bar to 10 bar, ensuring fast cooling and efficient operation of the workpiece after hot pressing;
 - **Good stability:** The equipment runs stably for a long time and has a very low failure rate;
 - **Good safety performance:** Adopting HMI+PLC+PID pressure sensing control, safe and reliable;
 - **Strong scalability:** Capable of sintering, annealing, degreasing, degassing, etc.

应用领域 / APPLICATIONS

本设备为周期作业式，可供石墨电极、陶瓷等在高温、高真空条件下进行烧结处理，也可在充入保护气氛情况下烧结，也可以对碳纤维毡进行气氛保护提纯处理，烧结工艺在许多如合金行业、冶金行业等工业行业得到大量应用如硬质合金、耐火材料、粉末冶金、超高温材料烧成等都需要应用烧结工艺。

如炭/炭刹车盘、炭炭板材、热压模具、高温发热体/紧固件、热场材料、石墨制品、碳纸、碳布、石墨烯、碳纳米管、导热膜等。

This equipment is a cycle operation type and can be used for graphite electrodes, ceramics, etc. under high temperature and high vacuum conditions, Sintering treatment can also be carried out under the condition of filling a protective atmosphere, or carbon fiber felt can be subjected to atmosphere treatment. Protection purification treatment and sintering process have been widely used in many industrial industries such as alloy and metallurgical industries. Applications such as hard alloys, refractory materials, powder metallurgy, and ultra-high temperature material firing all require application sintering process.

Such as carbon/carbon brake discs, carbon plates, hot pressing molds, high-temperature heating elements/fasteners, thermal field materials, Graphite products, carbon paper, carbon cloth, graphene, carbon nanotubes, thermal conductive films, etc.

产品规格及技术指标 / SPECIFICATIONS & PARAMETERS

产品编号 Numbering	产品型号 Model	有效区尺寸(mm) Chamber Size (mm)	极限真空度(Pa) Ultimate Vacuum (Pa)	工作温度(°C) Operating Temperature (°C)	适用工艺 Applications
V4GR20/23	VHSgr-40/40/60-T	400×400×600	6.7×10 ⁻³	2000/2300	烧结/退火/脱脂 Sintering/Annealing/Degreasing
V5GR20/23	VHSgr-50/50/70-T	500×500×700	6.7×10 ⁻³	2000/2300	烧结/退火/脱脂 Sintering/Annealing/Degreasing
V6GR20/23	VHSgr-60/60/90-T	600×600×900	6.7×10 ⁻³	2000/2300	烧结/退火/脱脂 Sintering/Annealing/Degreasing
V7GR20/23	VHSgr-70/70/100-T	700×700×1000	6.7×10 ⁻³	2000/2300	烧结/退火/脱脂 Sintering/Annealing/Degreasing

Vacuum Furnace (Moly)

真空炉(钼带加热卧式)

V Series



稳定性高 / 温度均匀性好 / 炉膛洁净度高 / 升温速度快 /
安全性能好 / 冷却速度快 / 拓展性强

Good Design Optimization / Temperature Uniformity / Fast Heating Speed /
High Pressure Accuracy / Good Safety Performance

V10M014正视图

V-10M014 Front View



简介 / BRIEF INTRODUCTION

该真空炉是用钼带作发热元件的真空电阻炉，主要应用于陶瓷、硬质合金、复合材料、金属材料等在真空或保护气氛中高温烧结、退火、钎焊，也可以供金属材料在真空条件下的高温热处理或贵金属材料的除气处理。

This vacuum furnace is a vacuum resistance furnace that uses molybdenum strips as heating elements, mainly used in ceramics. High temperature sintering and annealing of hard alloys, composite materials, metal materials, etc. in vacuum or protective atmosphere. Fire and brazing can also be used for high-temperature heat treatment of metal materials under high vacuum conditions or precious metals. Degassing treatment of materials.

应用领域 / APPLICATIONS

高真空钼带炉主要用于有色金属、不锈钢、钛合金、高温合金、硬质合金等材料烧结、退火、真空钎焊、除气等工艺。

High vacuum molybdenum strip furnace is mainly used for non-ferrous metals, stainless steel, titanium alloys, high-temperature alloys. Sintering, annealing, vacuum brazing, degassing and other processes for materials such as hard alloys.

技术特点 / ADVANTAGES

- 采用卧式、侧开门结构：装、卸料精度高，操作方便；
 - 升温快：升温速率10°C/分钟(≤1600°C)；
 - 温度均匀性好：平均温度均匀性为±3°C(5点测温，恒温区1000°C保温1h后检测)；
 - 采用多温区控制：预留多个测温孔，以便高温监测使用；
 - 安全性能好：采用HMI+PLC+PID压力传感控制，安全可靠；
 - 设计优化好：加热室热场经热态模拟计算，具有非常高的温度均匀性、配置的加热元件及隔热层采用模块化优化设计；
 - 冷却速度快：可选配2bar-10bar气体压力下快速冷却系统，保证工件快速冷却，高效运行；
 - 可拓展性强：可烧结、钎焊、退火、脱脂、脱氧、脱气、还原等。
- Adopting a horizontal and side opening door structure: high loading and unloading accuracy, easy operation;
 - **Fast heating:** heating rate of 10°C/minute (≤1600°C);
 - **Good temperature uniformity:** The average temperature uniformity is ±3°C (5-point temperature measurement, constant temperature zone 1000°C insulation for 1 hour before detection);
 - **Adopting multi temperature zone control:** reserving multiple temperature measurement holes for high-temperature monitoring purposes;
 - **Good safety performance:** Adopting HMI+PLC+PID pressure sensing control, safe and reliable;
 - **Good design optimization:** The heating chamber's thermal field has been simulated and calculated under thermal conditions, with very high temperature uniformity and compatibility. The heating elements and insulation layer are designed with modular optimization;
 - **Fast cooling speed:** optional with a fast cooling system under a gas pressure of 2bar-10bar to ensure the workpiece, fast cooling after completion and efficient operation;
 - **Strong scalability:** capable of sintering, brazing, annealing, degreasing, deoxidation, degassing, reduction, etc.

主要规格及技术指标 / SPECIFICATIONS & PARAMETERS

产品编号 Numbering	产品型号 Model	有效区尺寸(mm) Chamber Size (mm)	极限真空度(Pa) Ultimate Vacuum (Pa)	工作温度(°C) Operating Temperature (°C)	适用工艺 Applications
V5M010/14	VHSmo-50/50/70-T	500×500×700	6.7×10 ⁻⁴	1000/1300	烧结/退火/脱脂/氢气/钎焊/脱气 Sintering/Annealing/Hydrogen/Degreasing/Brazing/Degassing
V6M010/14	VHSmo-60/60/90-T	600×600×900	6.7×10 ⁻⁴	1000/1300	烧结/退火/脱脂/氢气/钎焊/脱气 Sintering/Annealing/Hydrogen/Degreasing/Brazing/Degassing
V7M010/14	VHSmo-70/70/100-T	700×700×1000	6.7×10 ⁻⁴	1000/1300	烧结/退火/脱脂/氢气/钎焊/脱气 Sintering/Annealing/Hydrogen/Degreasing/Brazing/Degassing
V8M010/14	VHSmo-80/80/120-T	800×800×1200	6.7×10 ⁻⁴	1000/1300	烧结/退火/脱脂/氢气/钎焊/脱气 Sintering/Annealing/Hydrogen/Degreasing/Brazing/Degassing

Vacuum Furnace (Tung Sten)

真空炉(钨带加热卧式)

V Series



稳定性高 / 温度均匀性好 / 炉膛洁净度高 / 升温速度快 /
安全性能好 / 冷却速度快 / 拓展性强

Good Design Optimization / Temperature Uniformity / Fast Heating Speed /
High Pressure Accuracy / Good Safety Performance

V6W20等轴测图

V6W20 Isometric View



简介 / BRIEF INTRODUCTION

该真空炉是用钨带作发热元件的真空电阻炉，主要应用于陶瓷、硬质合金、复合材料等在真空或保护气氛中高温烧结、退火，也可以供金属材料在高温真空条件下的高温热处理或贵金属材料的除气处理。

This vacuum furnace is a vacuum resistance furnace that uses tungsten strips as heating elements, mainly used in ceramics. Ceramics, hard alloys, composite materials, etc. are sintered and annealed at high temperatures under vacuum or protective atmosphere. It can also be used for high-temperature heat treatment of metal materials under high vacuum conditions or for the removal of precious metal materials gas treatment.

应用领域 / APPLICATIONS

主要用于金属粉末制品、金属丝网制品、陶瓷硬质合金、新材料及复合材料等真空烧结，应用于透明陶瓷、工业陶瓷等金属以及由难溶金属组成的合金材料以及陶瓷材料碳化硅及氮化硅的高温烧结。

It is mainly used for metal powder products, metal wire mesh products, ceramic cemented carbide, new materials and complexes. Vacuum sintering of composite materials, etc., is used in metals such as transparent ceramics and technical ceramics, as well as in insoluble materials. High-temperature sintering of alloy materials composed of metals and ceramic materials, silicon carbide and silicon nitride.



技术特点 / ADVANTAGES

- 采用卧式、侧开门结构：装、卸料精度高，操作方便；
 - 升温快：升温速率10°C/分钟(≤1600°C)；升温速率5°C/分钟(>1600°C)；
 - 温度均匀性好：平均温度均匀性为±5°C(5点测温，恒温区1000°C保温1h后检测)；
 - 安全性能好：采用HMI+PLC+PID压力传感控制，安全可靠；
 - 设计优化好：加热室热场经热态模拟计算，具有非常高的温度均匀性、配置的加热元件及隔热层采用模块化优化设计；
 - 自动化程度高：多参数记录监控，友善化人机界面，运行稳定；
 - 冷却速度快：可选配2bar气体压力下快速冷却系统，保证工件快速冷却，高效运行；
 - 可拓展性强：可烧结、退火、钎焊、脱气、氢气等。
- Adopting a horizontal and side opening door structure: high loading and unloading accuracy, easy operation;
 - **Fast heating:** heating rate of 10°C/minute (≤1600°C); Heating rate of 5°C/minute (>1600°C);
 - **Good temperature uniformity:** The average temperature uniformity is ±5°C (5-point temperature measurement, constant temperature zone 1000°C insulation for 1 hour before detection);
 - **Good safety performance:** Adopting HMI+PLC+PID pressure sensing control, safe and reliable;
 - **Good design optimization:** The heating chamber's thermal field has been simulated and calculated under thermal conditions, with very high temperature uniformity and compatibility. The heating elements and insulation layer are designed with modular optimization;
 - **High degree of automation:** multi parameter recording and monitoring, user-friendly human-machine interface, stable operation;
 - **Fast cooling speed:** optional with a fast cooling system under a gas pressure of 2bar to ensure the workpiece, Fast cooling after completion and efficient operation;
 - **Strong scalability:** capable of sintering, annealing, brazing, degassing, hydrogen gas, etc..

产品规格及技术指标 / SPECIFICATIONS & PARAMETERS

产品编号 Numbering	产品型号 Model	有效区尺寸(mm) Chamber Size (mm)	极限真空度(Pa) Ultimate Vacuum (Pa)	工作温度(°C) Operating Temperature (°C)	适用工艺 Applications
V3W18/20	VHSw-30/30/40-T	300×300×400	6.7×10 ⁻⁴	1800/2000	烧结/退火/氢气/钎焊/脱气 Sintering/Annealing/Degreasing/Brazing/Degassing
V4W18/20	VHSw-40/40/60-T	400×400×600	6.7×10 ⁻⁴	1800/2000	烧结/退火/氢气/钎焊/脱气 Sintering/Annealing/Degreasing/Brazing/Degassing
V5W18/20	VHSw-50/50/70-T	500×500×700	6.7×10 ⁻⁴	1800/2000	烧结/退火/氢气/钎焊/脱气 Sintering/Annealing/Degreasing/Brazing/Degassing
V6W18/20	VHSw-60/60/90-T	600×600×900	6.7×10 ⁻⁴	1800/2000	烧结/退火/氢气/钎焊/脱气 Sintering/Annealing/Degreasing/Brazing/Degassing

Vacuum Furnace (Induction)

真空炉(感应加热)

V Series



温度均匀性好 / 升温速度快 / 安全性能好 / 冷却速度快

Good Temperature Uniformity / Fast Heating Speed / Good Safety Performance / Fast Cooling Speed

V10C023等轴测图

V10C023 Isometric View



简介 / BRIEF INTRODUCTION

真空感应炉是采用感应加热方式，主要应用于陶瓷、硬质合金、复合材料等在真空或保护气氛中高温烧结、退火，也可以供金属材料在高真空条件下的高温热处理或贵金属材料的除气处理。

该设备的结构设计先进合理，设计及制造符合相应的国家及行业标准和规范，能够满足用户的使用要求。其配套产品和元器件具有国际先进水平，能够适应长期、稳定、安全、可靠的生产需求。

设备的节能效果好。使用、操作、维修方便简洁，造型美观，安全可靠，售后服务优良。

Vacuum induction furnace adopts induction heating method and is mainly used in ceramics, hard alloys, and composite materials, Composite materials can be sintered and annealed at high temperatures in vacuum or protective atmosphere, and can also be used for high-temperature heat treatment of metal materials under high vacuum conditions or degassing treatment of precious metal materials. The structural design of this equipment is advanced and reasonable, and the design and manufacturing comply with corresponding national and industry standards and specifications, which can meet the user's usage requirements. Its supporting products and components have international advanced level and can adapt to long-term, stable, safe, and reliable production needs. The energy-saving effect of the equipment is good. Convenient and simple to use, operate, and maintain, with beautiful appearance, safe and reliable, and excellent after-sales service

应用领域 / APPLICATIONS

本真空炉为周期作业式，可供石墨电极、陶瓷等在高温、高真空条件下进行烧结处理，也可在充入保护气氛情况下烧结，在许多钢铁行业、冶金行业、陶瓷行业等工业行业得到大量应用如硬质合金、陶瓷、耐火材料、粉末冶金、超高温材料烧成等都需要应用。

This Vacuum furnace is a periodic operation type, which can be used for graphite electrodes, ceramics, etc. under high temperature and high vacuum conditions, Sintering treatment can also be carried out under the condition of filling a protective atmosphere, which is widely used in many steel and metallurgical industries, The ceramic industry and other industrial industries have been widely applied, such as hard alloys, ceramics, refractory materials, and powder metallurgy gold, ultra-high temperature material firing, and other applications are required.

产品规格及技术指标 / SPECIFICATIONS & PARAMETERS

产品编号 Numbering	产品型号 Model	有效区尺寸(mm) Chamber Size (mm)	极限真空度(Pa) Ultimate Vacuum (Pa)	工作温度(°C) Operating Temperature (°C)	适用工艺 Applications
V8CO20/23	VHSc0-80/80/120-T	800×800×1200	6.7×10 ⁻³	2000/2300	烧结/退火/脱脂/氢气 Sintering/Annealing/Degreasing/Hydrogen
V10CO20/23	VHSc0-100/100/200-T	1000×1000×2000	6.7×10 ⁻³	2000/2300	烧结/退火/脱脂/氢气 Sintering/Annealing/Degreasing/Hydrogen

技术特点 / ADVANTAGES

- 采用卧式、侧开门结构：装、卸料精度高，操作方便；
 - 升温快：升温速率40°C/分钟(≤1600°C)，升温速率20°C/分钟(>1600°C)；
 - 采用多温区控制：预留多个测温孔，以便高温监测使用；
 - 安全性能好：采用HMI+PLC+PID压力传感控制，安全可靠；
 - 设计优化好：加热室感应热场经热态模拟计算，具有非常高的温度均匀性、配置的加热元件及隔热层采用模块化优化设计；
 - 可拓展：可烧结、退火、氢气等。
- Adopting a horizontal and side opening door structure: high loading and unloading accuracy, easy operation;
 - Fast heating: heating rate of 40°C/min(≤1600°C), heating rate of 20°C/min (>1600°C);
 - Adopting multi temperature zone control: reserving multiple temperature measurement holes for high-temperature monitoring purposes;
 - Good safety performance: Adopting HMI+PLC+PID pressure sensing control, safe and reliable;
 - Good design optimization: The induction thermal field in the heating chamber has been simulated and calculated in thermal state, with very high temperature uniformity and compatibility, The heating elements and insulation layer are designed with modular optimization;
 - Expandable: capable of sintering, annealing, hydrogen gas, etc..

V6CGR20等轴测图
V6CGR20 Isometric View



Continuous Vacuum Furnace

V Series

连续式真空炉



生产效率高 / 温度均匀性好 / 升温速度快 / 安全性能好 / 自动化程度高

High Production Efficiency / Good Temperature Uniformity / Fast Heating Speed / Good Safety Performance / High Degree Of Automation

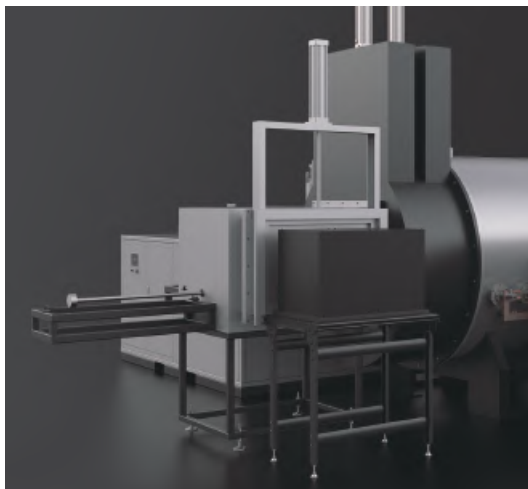

简介 / BRIEF INTRODUCTION

该连续式真空炉是用石墨作发热元件的真空电阻炉，主要应用于陶瓷、硬质合金、复合材料等在真空或保护气氛中高温烧结或退火等热处理工艺的成套设备，也可以供金属材料在高真空条件下的高温热处理或贵金属材料的除气处理。

连续式真空炉具有先进、生产自动化程度高、处理量大、热处理产品质量好等优点，可大大提高企业的生产效率，节约人工成本。

This continuous vacuum furnace is a vacuum resistance furnace that uses graphite as a heating element, mainly used in ceramics, hard alloys, A complete set of equipment for high-temperature sintering or annealing of composite materials in vacuum or protective atmosphere can also be used for high-temperature heat treatment of metal materials under high vacuum conditions or degassing treatment of precious metal materials.

Continuous vacuum furnaces have advantages such as advanced technology, high degree of production automation, large processing capacity, and good quality of heat treated products. It can greatly improve the production efficiency of enterprises and save labor costs.

V6CGR20等轴透视图

V6CGR20 Isometric Perspective View

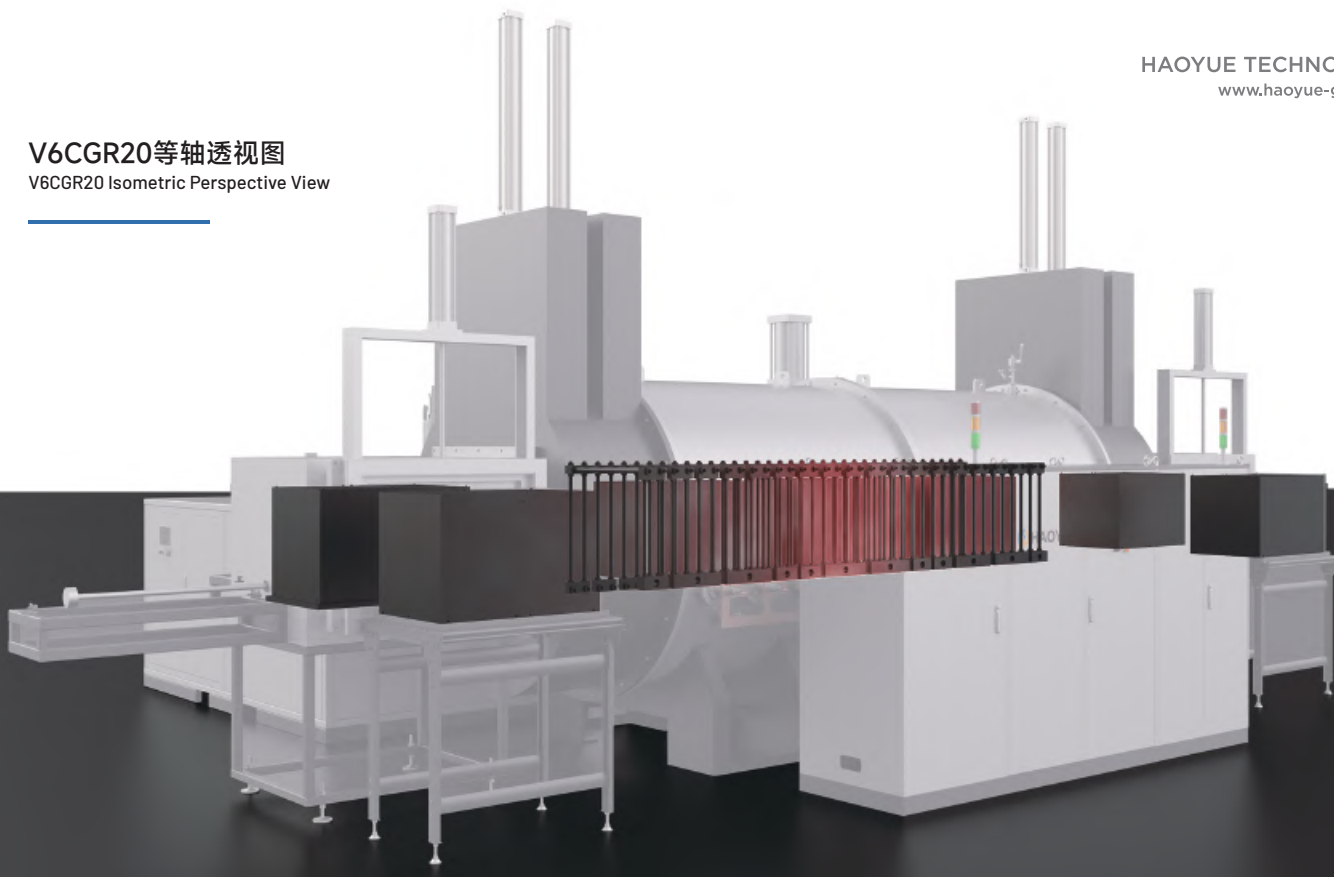

技术特点 / ADVANTAGES

- 采用多工位设计，可以连续生产，使得效率倍增；
 - 升温快：升温速率10°C/分钟(≤1600°C)，升温速率5°C/分钟(>1600°C)；
 - 设计优化好：加热室热场经热态模拟计算，具有非常高的温度均匀性、配置的加热元件及隔热层采用模块化优化设计；
 - 温度均匀性好：平均温度均匀性为±5°C(5点测温，恒温区1000°C保温1h后检测)；
 - 采用多温区控制：预留多个测温孔，以便高温监测使用；
 - 安全性能好：采用HMI+PLC+PID压力传感控制，安全可靠；
 - 自动化程度高：如选装自动装卸料系统，将可完全实现所有工序全自动运行，数字化、智能化、无需人工干预；
 - 可拓展：烧结、退火。
- Adopting a multi station design, continuous production can be achieved, resulting in doubled efficiency;
 - **Fast heating:** Heating rate of 10°C/minute(≤1600°C), heating rate of 5°C/minute (>1600°C);
 - **Good design optimization:** The heating chamber's thermal field has been simulated and calculated under thermal conditions, with very high temperature uniformity and compatibility. The heating elements and insulation layer are designed with modular optimization;
 - **Good temperature uniformity:** The average temperature uniformity is ± 5°C (5-point temperature measurement, constant temperature zone 1000 C insulation for 1 hour before detection);
 - **Adopting multi temperature zone control:** Reserving multiple temperature measurement holes for high-temperature monitoring purposes;
 - **Good safety performance:** Adopting HMI+PLC+PID pressure sensing control, safe and reliable;
 - **High degree of automation:** If an automatic loading and unloading system is selected, all processes can be fully automated, Digitalization, intelligence, and no need for manual intervention;
 - **Expandable:** Sintering, annealing.

应用领域 / APPLICATIONS

本设备为连续作业式，可供石墨电极、陶瓷等在高温、高真空条件下进行烧结处理，也可在充入保护气氛情况下烧结，也可以对碳纤维毡进行气氛保护提纯处理。

烧结工艺在许多钢铁行业、冶金行业、陶瓷行业等工业行业得到大量应用如硬质合金、陶瓷、耐火材料、粉末冶金、超高温材料烧成等都需要应用烧结工艺。如炭/炭刹车盘、炭炭板材、晶体炉热场、热压模具、高温发热体/紧固件、热场材料、石墨制品、碳纸、碳布、石墨烯、碳纳米管、导热膜等。

This equipment is a continuous operation type and can be used for graphite electrodes, ceramics, etc. under high temperature and high vacuum conditions, Sintering treatment can also be carried out under the condition of filling a protective atmosphere, or carbon fiber felt can be subjected to atmosphere protection and purification treatment.

Sintering technology has been widely applied in many industrial industries such as steel, metallurgy, and ceramics, Applications such as hard alloys, ceramics, refractory materials, powder metallurgy, and ultra-high temperature material firing are all required, Sintering process. Such as carbon/carbon brake discs, carbon plates, crystal furnace thermal field, hot pressing molds, and high-temperature heating, Body/fastener, thermal field materials, graphite products, carbon paper, carbon cloth, graphene, carbon nanotubes, thermal conductivity, Membrane, etc.

产品规格及技术指标 / SPECIFICATIONS & PARAMETERS

产品编号 Numbering	产品型号 Model	有效区尺寸(mm) Chamber Size (mm)	极限真空度(Pa) Ultimate Vacuum (Pa)	工作温度(°C) Operating Temperature (°C)	适用工艺 Applications
V6CGR20	VCSgr-60/60/90-2000	600×600×900	1	2000	烧结/退火 Sintering / Annealing
V8CGR20	VCSgr-80/80/120-2000	800×800×1200	1	2000	烧结/退火 Sintering / Annealing

Gas Pressure sintering Furnace (Graphite)

气压炉(石墨加热卧式/立式)

G Series



温度均匀性好 / 升温速度快 / 安全性能好 / 组织结构可控

Good Temperature Uniformity / Fast Heating Rate / Good Safety Performance / Controllable Organizational Structure

简介 / BRIEF INTRODUCTION

加压烧结炉系列集正压脱蜡、真空脱蜡、真空烧结、分压烧结、加压烧结、气氛控制、冷却等功能于一体。本产品为周期作业式，适用于氮化硅陶瓷球，陶瓷刀具等材料在高压氮气或氩气气氛内进行烧结，有利于增加材料的烧结密度，提高材料的机械性能。多种装料设计，使装卸与维修工作更为简便。整个工艺过程自动控制。

The pressure sintering furnace series includes positive pressure dewaxing, vacuum dewaxing, vacuum sintering, partial pressure sintering, and pressure sintering, Integrating functions such as knot, atmosphere control, and cooling. This product is a cycle operation type, suitable for nitriding, Sintering materials such as silicon ceramic balls and ceramic cutting tools in a high-pressure nitrogen or argon atmosphere is beneficial for Increase the sintering density of materials and improve their mechanical properties. Multiple loading designs enable loading and unloading to be coordinated with maintenance work is more convenient. The entire process is automatically controlled.

G5GR20正视图
G5GR20 Front View

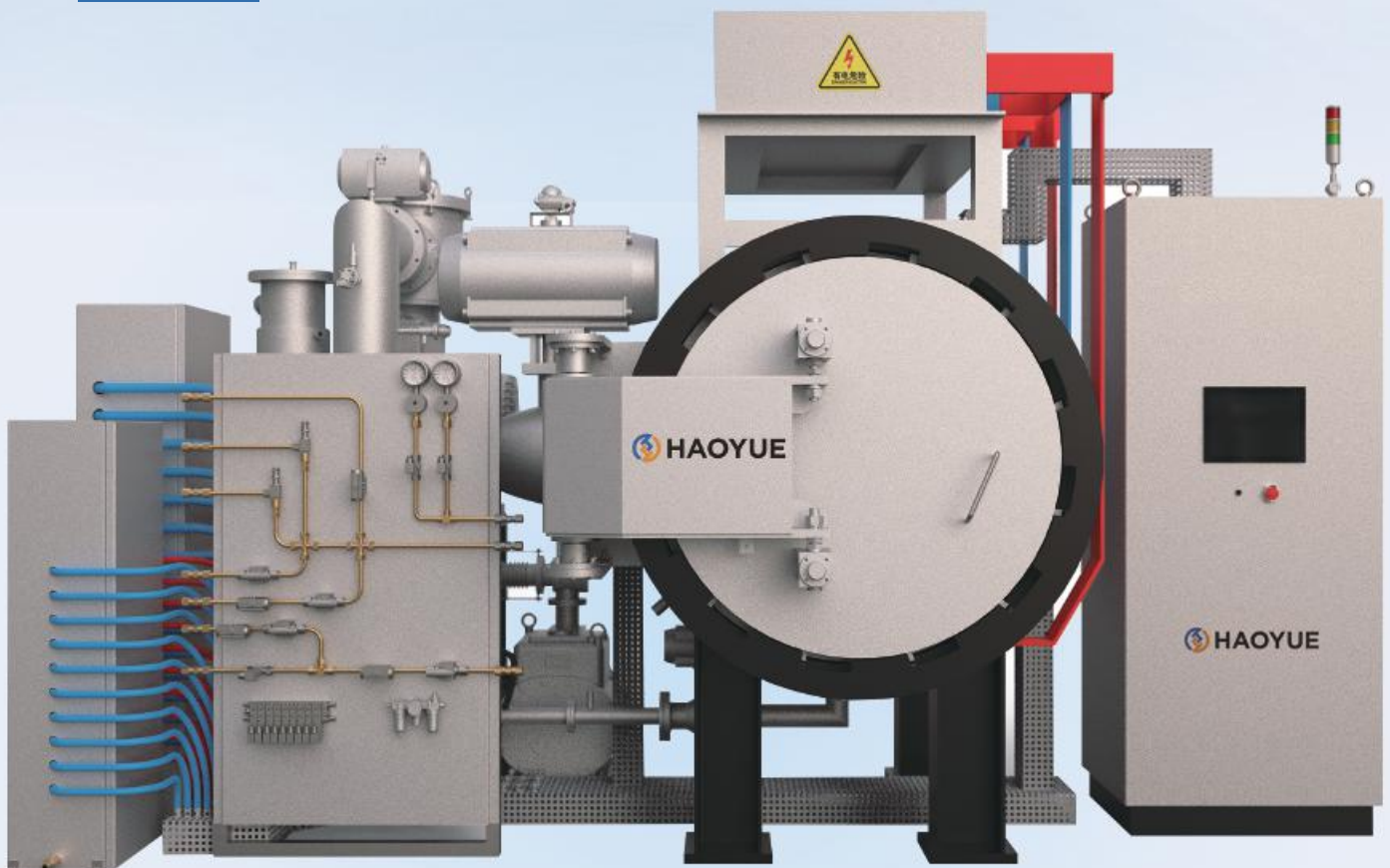

技术特点 / ADVANTAGES

- 卧式设计，使装卸与维修工作更为简便，整个工艺过程自动控制；
 - 温度均匀性好：采用特殊的炉胆结构和加热器布置，炉温均匀性好；
 - 脱脂效果好：采用特殊结构脱脂箱，密封效果好，脱脂完全对炉内元件无污染；
 - 功能多：具备真空烧结、压力烧结、负压脱脂等功能；
 - 设计优化好：加热室热场经热态模拟计算，具有非常高的温度均匀性、配置的加热元件及隔热层采用模块化优化设计；
 - 安全性高：具有超温超压等故障报警，机械式自动压力保护，动作互锁等功能，设备安全性高；
 - 设备可选择配置脱脂系统，实现陶瓷制品的脱脂烧结一次性处理。
- Horizontal design makes loading, unloading, and maintenance work more convenient. Automatic control of the entire process;
 - Good temperature uniformity: Adopting a special furnace liner structure and heater layout, the furnace temperature uniformity is good;
 - Good degreasing effect: using a special structure degreasing box, the sealing effect is good, and the degreasing is completely on the inside of the furnace components are pollution-free;
 - Multi functional: equipped with vacuum sintering, pressure sintering, negative pressure degreasing and other functions;
 - Good design optimization: The thermal field of the heating chamber has been simulated and calculated in thermal state, with very high temperature uniformity. The configured heating elements and insulation layer are designed with modular optimization;
 - High safety: equipped with fault alarms such as over temperature and over pressure, mechanical automatic pressure protection, and mutual action Lock and other functions;
 - High equipment safety: The equipment can be equipped with a degreasing system to achieve one-time degreasing and sintering treatment of ceramic products.

应用领域 / APPLICATIONS

在高气压保护气氛条件下对陶瓷（如碳化硅、氧化锆、氧化铝、氮化硅等）及金属材料（如硬质合金）等进行热等静压烧结处理，同时也适用大专院校、科研单位进行中试批量生产用。适用于氮化硅陶瓷球、陶瓷刀具等材料在高压氮气或氩气气氛内进行烧结。有利于增加材料的烧结密度，提高材料的机械性能。

Under high-pressure protective atmosphere conditions, ceramics (such as silicon carbide, zirconia, alumina, silicon nitride, etc.) and metal materials (such as hard alloys) are subjected to hot isostatic pressing sintering treatment, which is also suitable for pilot batch production in colleges and research institutions. Suitable for sintering materials such as silicon nitride ceramic balls and ceramic cutting tools in a high-pressure nitrogen or argon atmosphere. Beneficial for increasing the sintering density of materials and improving their mechanical properties.

G7VGR20等轴测图

G7VGR20 Isometric View



产品规格及技术指标 / SPECIFICATIONS & PARAMETERS

产品编号 Numbering	产品型号 Model	加热材质 Heater	设备形式 Structure	取料方式 Loading	有效工作区(mm) Chamber Size (mm)	工作温度(°C) Operating Temperature (°C)	气体压力(MPa) Gas Pressure (MPa)	极限真空度(Pa) Ultimate Vacuum (Pa)	适用工艺 Applications
G3VGR16/20	PVSgr-30/50-T	石墨 GR	立式 Vertical	下取料 Bottom Loading	Φ300×500	1600/2000	10	10Pa	烧结/分压烧结/脱脂/氢气 Gas Pressure Sintering/Partial Pressure Sintering/Degreasing/Hydrogen
G5VGR16/20	PVSgr-50/80-T	石墨 GR	立式 Vertical	下取料 Bottom Loading	Φ500×800	1600/2000	6/10	10Pa	烧结/分压烧结/脱脂/氢气 Gas Pressure Sintering/Partial Pressure Sintering/Degreasing/Hydrogen
G7VGR16/20	PVSgr-70/250-T	石墨 GR	立式 Vertical	上下取料 Top/Bottom Loading	Φ700×2500	1600/2000	6/10	10Pa	烧结/分压烧结/脱脂/氢气 Gas Pressure Sintering/Partial Pressure Sintering/Degreasing/Hydrogen
G3GR16/20	PHSgr-30/30/90-T	石墨 GR	卧式 Horizontal	侧取料 Side Loading	300×300×900	1600/2000	6	10Pa	烧结/分压烧结/脱脂/氢气 Gas Pressure Sintering/Partial Pressure Sintering/Degreasing/Hydrogen
G4GR16/20	PHSgr-40/40/120-T	石墨 GR	卧式 Horizontal	侧取料 Side Loading	400×400×1200	1600/2000	6/10	10Pa	烧结/分压烧结/脱脂/氢气 Gas Pressure Sintering/Partial Pressure Sintering/Degreasing/Hydrogen
G5GR16/20	PHSgr-50/50/180-T	石墨 GR	卧式 Horizontal	侧取料 Side Loading	500×500×1800	1600/2000	6/10	10Pa	烧结/分压烧结/脱脂/氢气 Gas Pressure Sintering/Partial Pressure Sintering/Degreasing/Hydrogen

Vacuum Hydrogen Furnace

氢气炉 H Series

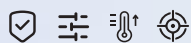

安全性能好 / 温度均匀性好 / 升温速度快 / 温度控制精度高

Good Safety Performance / Temperature Uniformity / Fast Heating Speed / High Temperature Control Accuracy

立式结构 / VERTICAL STRUCTURE

V65/320V正视图

V65/320V Front View



卧式结构 / HORIZONTAL STRUCTURE

V10M014正视图

V10M014 Front View

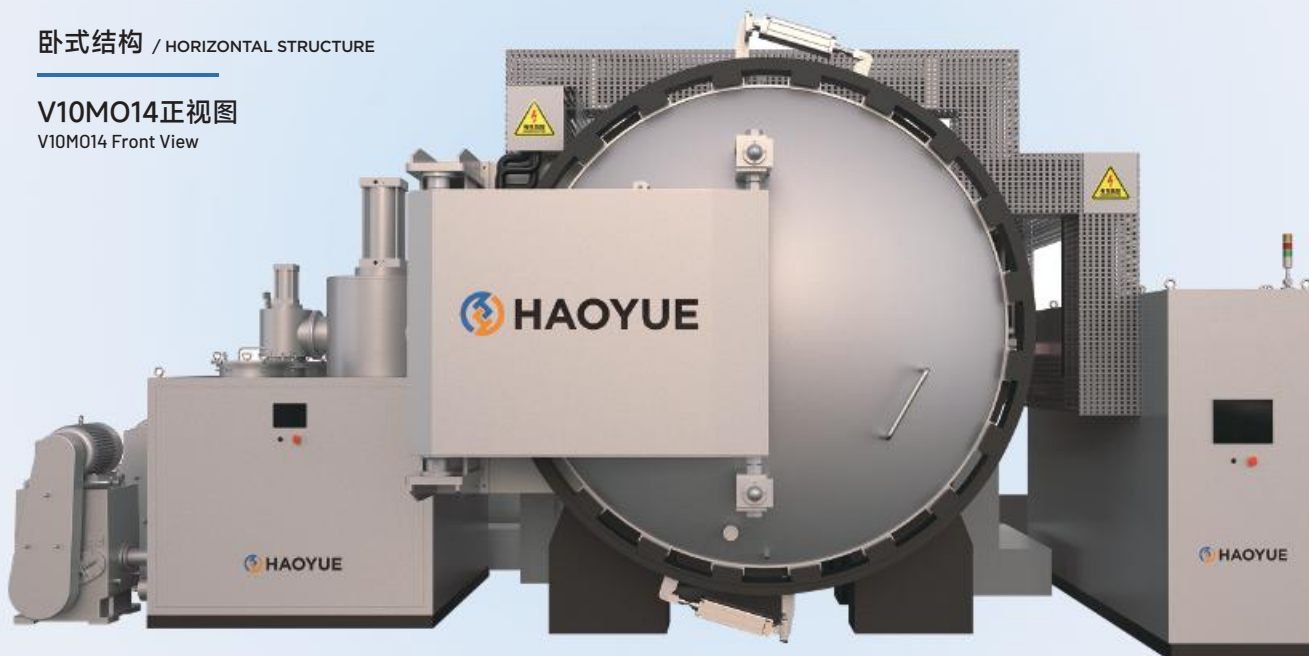

简介 / BRIEF INTRODUCTION

真空氢气炉是用钼带作发热元件的真空电阻炉，主要应用于陶瓷、硬质合金、复合材料等在真空或保护气氛中高温烧结，也可以供金属材料在真空条件下的高温热处理或贵金属材料的除气处理。

该设备的结构设计先进合理，设计及制造符合相应的国家及行业标准和规范，能够满足用户的使用要求。其配套产品和元器件具有国际先进水平，能够适应长期、稳定、安全、可靠的生产需求。设备的节能效果好。使用、操作、维修方便简捷，造型美观，安全可靠，售后服务优良。

Vacuum hydrogen furnace is a vacuum resistance furnace that uses molybdenum strips as heating elements. It is mainly used for high-temperature sintering of ceramics, hard alloys, composite materials, etc. in vacuum or protective atmosphere. It can also be used for high-temperature heat treatment of metal materials under high vacuum conditions or degassing treatment of precious metal materials. The structural design of this equipment is advanced and reasonable, and the design and manufacturing comply with corresponding national and industry standards and specifications, which can meet the user's usage requirements. Its supporting products and components have international advanced level and can adapt to long-term, stable, safe, and reliable production needs. The energy-saving effect of the equipment is good. Convenient and simple to use, operate, and maintain, with a beautiful appearance, safe and reliable, and excellent after-sales service.

技术特点 / ADVANTAGES

- 炉体采用立式结构，柱状结构的炉胆使得气流分布均匀，寿命均一，并且外壳材质采用双层SUS304不锈钢材质；
 - 加热元件采用在高温下力学性能优良的钼带，其表面负荷被确定合理的范围内。和炉体采用立式结构，传热快，维修更换简便，快捷；
 - 升温快：升温速率10°C/分钟(≤1400°C)；
 - 设计优化好：加热室热场经热态模拟计算，具有非常高的温度均匀性、配置的加热元件及隔热层采用模块化优化设计；
 - 本设备具有投资少、运行成本低、安装简单、使用维护方便、安全性能高，调节性能好等特点；
 - 安全性高：具有超温超压等故障报警，机械式自动压力保护，动作互锁等功能，设备安全性高；
- The furnace body adopts a vertical structure, and the columnar structure of the furnace liner ensures uniform airflow distribution and uniform service life. The outer shell material is made of double-layer SUS304 stainless steel material;
 - The heating element adopts molybdenum strip with excellent mechanical properties at high temperatures, and its surface load is determined within a reasonable range. The furnace body adopts a vertical structure, which has fast heat transfer, easy maintenance and replacement, and is fast;
 - **Fast heating:** heating rate of 10°C/minute (≤1400°C);
 - **Good design optimization:** The thermal field of the heating chamber has been simulated and calculated in thermal state, with very high temperature uniformity. The configured heating elements and insulation layer are designed with modular optimization;
 - This equipment has the characteristics of low investment, low operating cost, simple installation, convenient use and maintenance, high safety performance, and good adjustment performance;
 - **High safety:** equipped with fault alarms such as over temperature and pressure, mechanical automatic pressure protection, action interlocking and other functions, ensuring high equipment safety.

应用领域 / APPLICATIONS

用于陶瓷烧结或金属化、钎焊、玻璃零件封接用的金属零件退火和净化等的设备。

主要用于工具钢、模具钢、高速钢、超高强度钢、磁性材料、不锈钢、有色金属等材料在氢气气氛状态下的热处理。

Equipment for annealing and purifying metal parts used for ceramic sintering or metalization, brazing, and sealing of glass parts.

Mainly used for heat treatment of tool steel, mold steel, high-speed steel, ultra-high strength steel, magnetic materials, stainless steel, non-ferrous metals and other materials in a hydrogen atmosphere.

立式结构

V65/320V等轴测图
V65/320V Isometric View



产品规格及技术指标 / SPECIFICATIONS & PARAMETERS

产品编号 Numbering	产品型号 Model	加热材质 Heater	设备形式 Structure	取料方式 Loading	有效工作区(mm) Chamber Size (mm)	极限真空度(Pa) Ultimate Vacuum (Pa)	工作温度(°C) Operating Temperature (°C)
V65/120V	VVSmO-65/120-T	钼带 MO	立式 Vertical	下取料 Bottom Loading	Φ650×1200	6.7×10 ⁻⁴	1000/1400
V65/320V	VVSmO-65/320-T	钼带 MO	立式 Vertical	上取料 Top Loading	Φ650×3200	6.7×10 ⁻⁴	1000/1400
V4MO10/14	VHSmO-40/40/60-T	钼带 MO	卧式 Horizontal	侧取料 Side Loading	400×400×600	6.7×10 ⁻⁴	1000/1400
V6MO10/14	VHSmO-60/60/90-T	钼带 MO	卧式 Horizontal	侧取料 Side Loading	600×600×900	6.7×10 ⁻⁴	1000/1400
V8MO10/14	VHSmO-80/80/120-T	钼带 MO	卧式 Horizontal	侧取料 Side Loading	800×800×1200	6.7×10 ⁻⁴	1000/1400
V10MO10/14	VHSmO-100/100/200-T	钼带 MO	卧式 Horizontal	侧取料 Side Loading	1000×1000×2000	6.7×10 ⁻⁴	1000/1400

Chemical Vapor Deposition Furnace (CVD/CVI)

气相沉积炉(CVD/CVI)

C Series

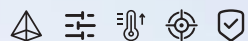

设备稳定性高 / 温度均匀性好 / 升温速度快 / 控制精度高 / 安全性能好

High Equipment Stability / Good Temperature Uniformity / Fast Heating Speed /

High Control Accuracy / Good Safety Performance

C8VGR16等轴测图

C8VGR16 Isometric View



简介 / BRIEF INTRODUCTION

热诱导化学气相沉积 (英语:chemical vapor deposition ,CVD)是用于各种电介质,半导体和金属材料的保护涂层的沉积的有力方式,无论是单晶,多晶,无定形或外延状态上大或小的形态。典型的涂层材料包括热解碳,碳化硅,氮化硼。通过使用合成前体,涂层非常纯净并且满足半导体工业的典型要求,根据工艺参数,可以有多种层厚度,从单个或几个原子层到厚度从10纳米到数百微米的固体保护层或功能层,以及厚度达100微米的单片部件,甚至高达数毫米。

热诱导的化学气相渗透(英语:chemical vapor infiltration ,CVI)是一个与CVD有关的技术,以在基体材料渗入多孔或纤维预成型件以制备由复合材料制成的部件具有改善的机械性能,耐腐蚀性,耐热冲击性和低残余应力。

Thermal induced chemical vapor deposition (CVD) is a powerful method for depositing protective coatings on various dielectrics, semiconductors, and metal materials, whether in single crystal, polycrystalline, amorphous, or epitaxial states, in large or small forms. Typical coating materials include pyrolytic carbon, silicon carbide, and boron nitride. By using synthetic precursors, the coating is very pure and meets the typical requirements of the semiconductor industry. Depending on process parameters, there can be multiple layers, ranging from single or several atomic layers to solid protective or functional layers with thicknesses ranging from 10 nanometers to hundreds of micrometers, as well as single chip components with thicknesses up to 100 micrometers, and even up to several millimeters.

Thermal induced chemical vapor infiltration (CVI) is a technique related to CVD, which involves infiltrating porous or fiber preforms into a matrix material to prepare components made of composite materials with improved mechanical properties, corrosion resistance, heat resistance to impact, and low residual stress.

应用领域 / APPLICATIONS

化学气相沉积炉(碳化硅)可用于以硅烷为气源的材料表面抗氧化涂层、基体改性等。立式化学气相沉积炉(沉积炭)可用于以碳氢气体(如C₃H₈、CH₄等)为碳源的材料表面或基体等温CVD/CVI处理。

卧式化学气相沉积炉(SiC、BN)可用于材料的表面涂层、基体改性、复合材料制备等外延片基座、晶体炉高温耐材、热弯模具、半导体坩埚、陶瓷基复合材料等。

技术特点 / ADVANTAGES

- 采用立式、底/顶开门结构:装、卸料精度高,操作方便;
 - 采用先进的控制技术,能精密控制MTS的流量和压力,炉膛内沉积气流稳定,压力波动范围小
 - 温度均匀性好:平均温度均匀性为±5°C;
 - 采用多通道沉积气路,流场均匀,无沉积死角,沉积效果好;
 - 全封闭沉积室,密封效果好,抗污染能力强;
 - 安全性能好:采用HMI+PLC+PID压力传感控制,安全可靠;
 - 对沉积产生的高腐蚀性尾气、易燃易爆气体、固体粉尘及低熔点粘性产物能进行有效处理;
 - 多级高效尾气处理系统,环境友好,能高效收集焦油及副产物,易清理;
 - 采用设计防腐蚀真空机组,持续工作长时间,维修率极低。
- Adopting a vertical, bottom/top door opening structure: high loading and unloading accuracy, easy operation;
 - Adopting advanced control technology, it can precisely control the flow and pressure of MTS, stabilize the sedimentation airflow in the furnace, and have a small range of pressure fluctuations;
 - Good temperature uniformity: the average temperature uniformity is ±5°C;
 - Adopting a multi-channel sedimentation gas path, the flow field is uniform, there are no dead corners of sedimentation, and the sedimentation effect is good;
 - Fully enclosed sedimentation chamber, with good sealing effect and strong anti-pollution ability;
 - Good safety performance: Adopting HMI+PLC+PID pressure sensing control, safe and reliable;
 - Effectively treat highly corrosive exhaust gas, flammable and explosive gases, solid dust, and low melting point viscous products generated by sedimentation;
 - Multi stage efficient exhaust gas treatment system, environmentally friendly, capable of efficiently collecting tar and by-products, easy to clean;
 - Adopting a corrosion-resistant vacuum unit with a long continuous working time and extremely low maintenance rate;

Chemical vapor deposition furnaces (silicon carbide) can be used for surface oxidation resistant coatings and matrix modification of materials using silane as the gas source. Vertical chemical vapor deposition furnace (sedimentary carbon) can be used for materials using hydrocarbon gases (such as C₃H₈, CH₄, etc.) as carbon sources.

Surface or substrate isothermal CVD/CVI treatment. Horizontal chemical vapor deposition furnaces (SiC, BN) can be used for surface coating of materials, matrix modification, composite material preparation, etc.. Substrates for epitaxial wafers, high-temperature refractory materials for crystal furnaces, hot bending molds, semiconductor crucibles, ceramic based composite materials, etc.

产品规格及技术指标 / SPECIFICATIONS & PARAMETERS

产品编号 Numbering	产品型号 Model	有效工作区(mm) Chamber Size (mm)	极限真空度(Pa) Ultimate Vacuum (Pa)	工作温度(°C) Operating Temperature (°C)	适用工艺 Applications
C4VGR16	VVCgr-56/60-1600	Φ560×600	1	1600	CVD/CVI
C6VGR16	VVCgr-84/90-1600	Φ840×900	1	1600	CVD/CVI
C8VGR16	VVCgr-110/120-1600	Φ1100×1200	1	1600	CVD/CVI
C10VGR16	VVCgr-140/200-1600	Φ1400×2000	1	1600	CVD/CVI

Vacuum Diffusion Welding Furnace

真空扩散焊炉

D Series



温度均匀性好 / 升温速度快 / 压力精度高 / 安全性能好 / 冷却速度快

Good Temperature Uniformity / Fast Heating Speed / High Pressure Accuracy /
Good Safety Performance / Fast Cooling Speed

简介 / BRIEF INTRODUCTION

扩散焊是指将工件在高温下加压，但不产生可见变形和相对移动的固态焊方法。扩散焊特别适合异种金属材料、耐热合金和陶瓷、金属间化合物、复合材料等新材料的接合，尤其是对熔焊方法难以焊接的材料，扩散焊具有明显的优势，日益引起人们的重视。

Difusionwelding refersto a solid-statewelding method inwhich a workpiece is pressurized at a hightemperature, but does not produce visible deformation and relative movement. Difusionwelding is especially suitableforthejoining ofdissimilar metal materials, heat-resistant alloys and new materials such as ceramics, intermetallic compounds, composite materials, etc., especiallyfor materialsthat are diiculttoweld byfusionwelding methods, difusionwelding has obvious advantages and has attracted more and moreattention.

D8M014等轴测图

D8M014 Isometric View



技术特点 / ADVANTAGES

- 扩散焊时因基体不过热、不熔化，可以在不降低被焊材料性能的情况下焊接几乎所有的金属或非金属材料，特别适合于熔焊和其他方法难以焊接的材料，如活性金属、耐热合金、陶瓷和复合材料等。对于塑性差或熔点高的同种材料，以及不互溶或在熔焊时会产生脆性金属间化合物的异种材料，扩散焊是较适宜的焊接方法。
- 扩散焊接头质量好，其显微组织和性能与母材接近或相同，在焊缝中不存在熔焊缺陷，也不存在过热组织和热影响区。焊接参数易于精确控制，批量生产时接头质量和性能稳定。
- 焊件精度高、变形小。因焊接时所加压力较小，工件多是整体加热，随炉冷却，故焊件整体塑性变形很小，焊后的工件一般不再进行机械加工。
- 可以焊接大截面工件为焊接所需压力不大，故大截面焊接所需设备的吨位不高，易于实现。
- 可以焊接结构复杂、接头不易接近以及壁厚相差较大的工件，能对组装件中的许多接头同时实施焊接。
- 冷却速度快：可选配2bar-10bar气体压力下快速冷却系统，保证工件热压完毕快速冷却，高效运行。
- Diffusion welding can weld almost all metals or non-metals without reducing the performance of the welded material, as the substrate does not overheat or melt. It is particularly suitable for fusion welding and other materials that are difficult to weld, such as active metals, heat-resistant alloys, ceramics, and composite materials. For the same type of material with poor plasticity or high melting point, as well as dissimilar materials that are immiscible or produce brittle intermetallic compounds during fusion welding, diffusion welding is a more suitable welding method.
- The diffusion welded joint has good quality, and its microstructure and properties are similar or identical to the base metal. There are no fusion welding defects, overheating structure, and heat affected zone in the weld seam. Welding parameters are easy to precisely control, and joint quality and performance are stable during mass production.
- Welding parts have high accuracy and small deformation. Due to the low pressure applied during welding, the workpiece is mostly heated as a whole and cooled with the furnace, resulting in minimal overall plastic deformation of the welded part. The welded workpiece is generally not subjected to mechanical processing.
- It is possible to weld large section workpieces with relatively low welding pressure, so the tonnage of equipment required for large section welding is not high, making it easy to achieve.
- It can weld workpieces with complex structures, difficult to access joints, and significant thickness differences, and can simultaneously weld many joints in the assembled parts.
- Fast cooling speed: optional with a fast cooling system under a gas pressure of 2 bar to 10 bar, ensuring fast cooling and efficient operation of the workpiece after hot pressing;

应用领域 / APPLICATIONS

扩散焊特别适用于要求真空密封，要求接头与母材等强度，要求无变形的小零件。它是制造真空密封、耐热、耐振和不变形接头的唯一方法，因此在工业生产中得到广泛的应用。在电真空设备中金属与非金属的焊接，切削刀具中硬质合金、陶瓷、高速钢与碳钢的焊接，都有采用扩散焊接的方法。超音速飞机上的各种钛合金部件都是用超塑性成形-扩散焊接法制造的。还特别适用于焊接异种金属材料、石墨和陶瓷等非金属材料、弥散强化高温合金、金属基复合材料和多孔烧结材料。

扩散焊接已广泛应用于反应堆燃料元件、液压泵耐磨件、钻机、隼头、耐腐蚀件、蜂窝结构板、静电、叶轮、冲压模具、过滤管和电子元件的制造中。

Diffusion welding is especially suitable for small parts that require vacuum sealing, equal strength of joints and base metals, and no deformation. It is the only way to manufacture vacuum-sealed, heat-resistant, vibration-resistant, and deform-free joints, so it is widely used in industrial production. Diffusion welding methods are used for the welding of metals and non-metals in electric vacuum equipment, and the welding of cemented carbide, ceramics, high-speed steel and carbon steel in cutting tools.

Varioustitanium alloy components on supersonic aircraft are manufactured using the superplastic forming-diffusion welding method.

The joint performance of diffusion welding can be the same as that of the base metal, and it is especially suitable for welding dissimilar metal materials, non-metallic materials such as graphite and ceramics, dispersion strengthened superalloys, metal matrix composites and porous sintered materials.

Diffusion welding has been widely used in the manufacture of reactor fuel elements, hydraulic pump wear parts, drilling rig oil shoe parts, corrosion resistant parts, honeycomb structural plates, electrostatics, impellers, stamping dies, filter tubes, and electronic components.

D8MO14正视图 D8MO14 Front View



产品规格及技术指标 / SPECIFICATIONS & PARAMETERS

产品编号 Numbering	产品型号 Model	有效区尺寸(mm) Chamber Size (mm)	极限真空度(Pa) Ultimate Vacuum (Pa)	压力(吨) Pressure (ton)	工作温度(°C) Operating Temperature (°C)	压头数量 Punch Qty.	气冷压强 Cooling Gas	应用范围 Applications
D4MO14	VHDBmo-40/40/60-1400	400×400×600	6.7×10 ⁻⁴	30~300	1400	1/2	2-10Bar	扩散焊 Diffusion Welding
D6MO14	VHDBmo-60/60/60-1400	600×600×600	6.7×10 ⁻⁴	50~500	1400	1/2	2-10Bar	扩散焊 Diffusion Welding
D8MO14	VHDBmo-80/60/80-1400	800×600×800	6.7×10 ⁻⁴	200~1000	1400	2/4	2-10Bar	扩散焊 Diffusion Welding
D10MO14	VHDBmo-100/60/100-1400	1000×600×1000	6.7×10 ⁻⁴	300~1000	1400	2/4	2-10Bar	扩散焊 Diffusion Welding

R8A10正视图
R8A10 Front View



Rotary Furnace (Batch)

间歇式回转窑 R Series



温度均匀性好 / 升温速度快 / 操作方便 / 安全性能好

Good Temperature Uniformity / Fast Heating Speed /
Convenient Operation / Good Safety Performance



简介 / BRIEF INTRODUCTION

间歇式回转窑以优质电阻丝为加热元件，采用双层壳体结构，30段程序控温系统，移相触发、可控硅控制，炉膛采用进口高纯氧化铝多晶体纤维材料，双层炉壳间配有风冷系统，能快速升降温，采用高纯310S不锈钢管，该炉具有温场均衡、表面温度低、升降温度速率快、节能等优点。

该回转窑采用国际先进技术，可开启回转式炉型。主要针对于粉料的混烧，仪器运行时炉管可以360°转动，且炉体可以倾斜，倾斜角度可达到0.5-6°，可以增加粉料烧结的均匀性，因而特别适合锂电材料的烧结和其他化合物的反应烧结等。

This batch rotary kiln of Haoyue Technology uses high-quality resistance wire as the heating element and adopts a double-layer shell junction structure, 30-stage programmed temperature control system, phase shift trigger, thyristor control, furnace using imported high-purity oxygen Aluminium polycrystalline fiber material, double-layer furnace shell is equipped with an air cooling system, which can quickly raise and fall the temperature. High-purity 310S stainless steel tube, the furnace has a balanced temperature field, low surface temperature, fast temperature rise and fall rate, Energy saving and other advantages.

The rotary kiln adopts international advanced technology and can open the rotary furnace type. It is mainly aimed at mixing powders. When the instrument is running, the furnace tube can rotate 360°, and the furnace body can be tilted, and the tilt angle can be reached 0.5-6°, which can increase the uniformity of powder sintering, so it is especially suitable for the sintering of lithium battery materials reaction sintering of other compounds, etc. The diameter of this rotary furnace is optional, and the heating zone can be customized.

R8A10等轴测图 R8A10 Isometric View

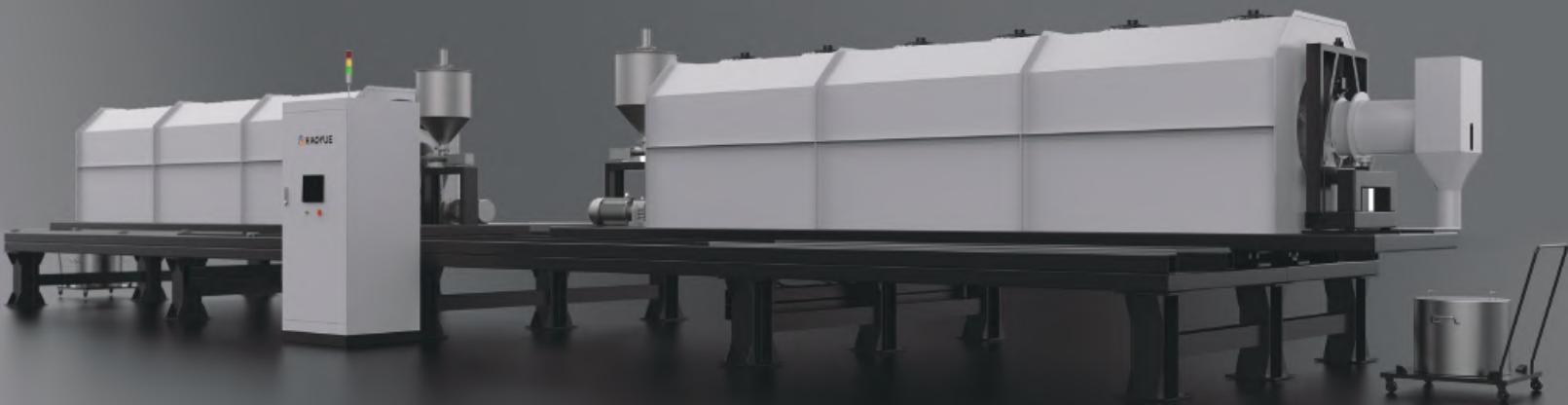

技术特点 / ADVANTAGES

- 结构紧凑，操作简单易维护；
 - 气氛控制精度高，自动控温；
 - 采用动态烧结方式，大幅提高热效率；
 - 耐高温，配置冷却系统；
 - 特制金属内胆，耐腐蚀；
 - PLC控制、触摸屏进行人机交互；
 - 全密封结构，保护气体用量小；
 - 采用动态烧结方式，无过烧和夹生现象。
- Compact structure, simple operation and easy maintenance;
 - High precision of atmosphere control and automatic temperature control;
 - Adopt dynamic sintering method to greatly improve thermal efficiency;
 - Complete exhaust gas treatment system;
 - Special metal liner, corrosion resistant;
 - PLC control, touch screen for human-computer interaction;
 - Fully sealed structure, small amount of protective gas.

应用领域 / APPLICATIONS

适用材料：锂电正负极材料、磁性材料、纳米材料等粉体材料。
制备石墨负极材料专用设备，可作为二烧设备。

Applicable materials: lithium battery cathode and anode materials, magnetic materials, nano materials and other powder materials.

Special equipment for preparing graphite anode materials, which can be used as secondary ring equipment.



产品规格及技术指标 / SPECIFICATIONS & PARAMETERS

产品编号 Numbering	产品型号 Model	加热材质 Heater	设备形式 Form	内胆直径×有效长(mm) Tube Size (mm)	工作温度(°C) Operating Temperature (°C)	炉管材质 Tube Material	加热功率(KW) Heating Power (KW)	其它性能参数 Note
R2A10	VRSa-27.3/50-1000	电阻丝 Resistance Wires	间歇式 Batch	Φ273×500	1000	SUS310S	18	有效容积: 6L; 转速: 0-10rpm; 气体流量: 20L/min Effective Volume: 6L; Speed: 0-10rpm; Gas flow: 20L/min
R4A10	VRSa-40/60-1000	电阻丝 Resistance Wires	间歇式 Batch	Φ400×600	1000	SUS310S	27	有效容积: 6L; 转速: 0-10rpm; 气体流量: 6m³/h Effective Volume: 6L; Speed: 0-10rpm; Gas flow: 6m³/h
R8A10	VRSa-80/600-1000	电阻丝 Resistance Wires	间歇式 Batch	Φ800×6000	1000	SUS310S	157	有效容积: 200L; 转速: 0-10rpm; 气体流量: 20m³/h Effective Volume: 20L; Speed: 0-10rpm; Gas flow: 20m³/h



R6CA9.5等轴测图
R6CA9.5 Isometric View

Continuous Rotary Furnace

R Series

连续式回转窑

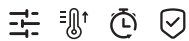

温度均匀性好 / 升温速度快 / 生产效率高 / 安全性能好

Good Temperature Uniformity / Fast Heating Speed /
High Production Efficiency / Good Safety Performance



简介 / BRIEF INTRODUCTION

这款连续式回转窑以优质电阻丝为加热元件，采用双层壳体结构，30段程序控温系统，移相触发、可控硅控制，炉膛采用进口高纯氧化铝多晶纤维材料，双层炉壳间配有风冷系统，能快速升降温，采用高纯310S不锈钢或其他耐腐蚀管，该炉具有温场均衡、表面温度低、升降温度速率快、节能等优点。

该回转窑采用国际先进技术，主要针对于粉料的混烧，仪器运行时炉管可以360°转动，且炉体可以倾斜，倾斜角度可达到0.5-6°，可以增加粉料烧结的均匀性，因而特别适合锂电材料的烧结和其他化合物的反应烧结等。此回转炉的直径可选，加热区可以定制。

This continuous rotary furnace of Haoyue Technology uses high-quality resistance wire as the heating element, adopts double-layer shell structure, 30-stage programmed temperature control system, phase shift trigger, thyristor control, the furnace is made of imported high-purity alumina polycrystalline fiber material, and the double-layer furnace shell is equipped with an air-cooling system, which can quickly raise and fall the temperature, and adopts high-purity 310s stainless steel tube, which has the advantages of balanced temperature field, low surface temperature, fast temperature rise and fall rate, and energy saving.

The rotary kiln adopts international advanced technology, mainly for the mixing of powder, the furnace tube can rotate 360° when the instrument is running, and the furnace body can be tilted, the inclination angle can reach 0.5-6°, which can increase the uniformity of powder sintering, so it is especially suitable for the sintering of lithium battery materials and the reaction sintering of other compounds. The diameter of this rotary furnace is optional, and the heating zone can be customized.

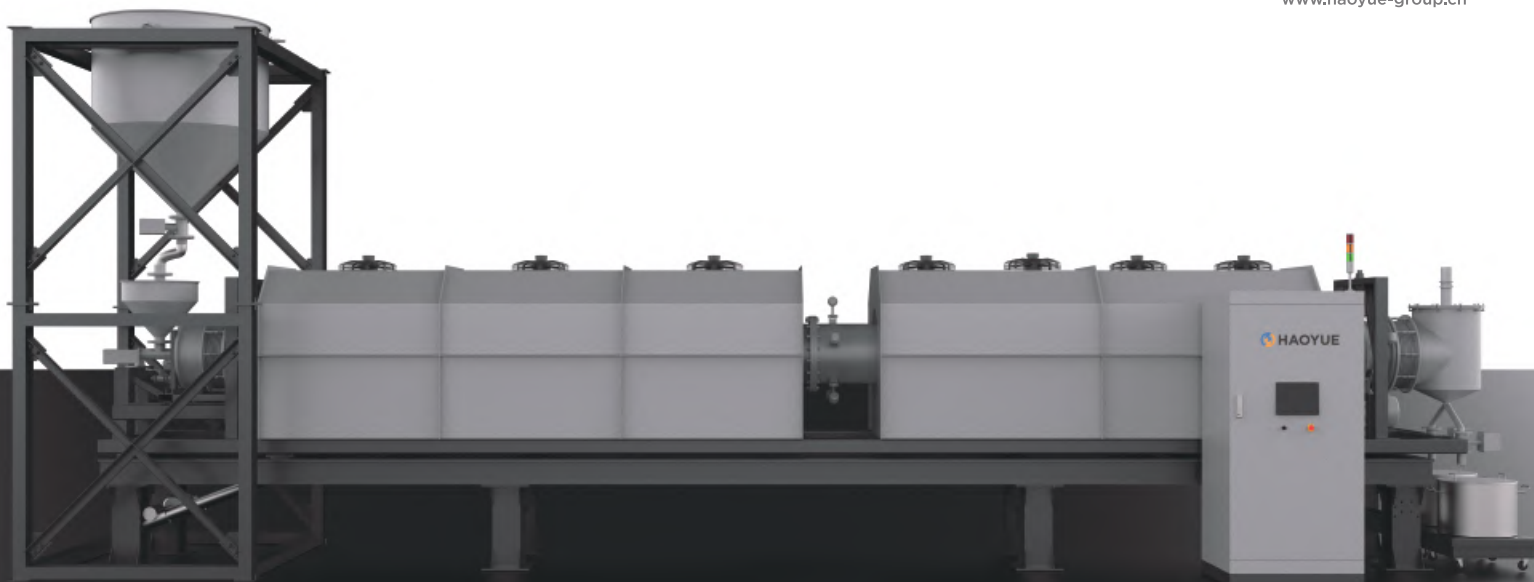

R6CA9.5正视图
R6CA9.5 Front View

技术特点 / ADVANTAGES

- 结构紧凑，操作简单易维护；
 - 气氛控制精度高，自动控温；
 - 采用动态烧结方式，大幅提高热效率；
 - 特制金属内胆，耐腐蚀；
 - PLC控制、触摸屏进行人机交互；
 - 全密封结构，保护气体用量小；
 - 连续生产，产能大幅提高；
 - 采用动态烧结方式，无过烧和夹生现象；
 - 自动化程度高：如选装自动装卸料系统，将可完成所有工序全自动运行，数字化、智能化、无需人工干预。
- Compact structure, simple operation and easy maintenance;
 - High precision atmosphere control, automatic temperature control;
 - Adopting dynamic sintering method to significantly improve thermal efficiency;
 - Specially made metal liner, corrosion-resistant;
 - PLC control and touch screen for human-machine interaction;
 - Fully sealed structure, low amount of protective gas used;
 - Continuous production and significant increase in production capacity;
 - Adopting dynamic sintering method, there is no overburning or entrainment phenomenon.
 - High automation program: If an automatic loading and unloading system is selected, all processes can be fully automated, digitized, intelligent, and without the need for manual intervention.

产品规格及技术指标 / SPECIFICATIONS & PARAMETERS

产品编号 Numbering	产品型号 Model	加热材质 Heater	设备形式 Device Form	内胆直径×有效长(mm) Chamber Size (mm)	工作温度(°C) Operating Temperature(°C)	炉管材质 Tube Material	加热功率(KW) Heating Power(KW)	其它性能参数 Note
R2CA9.5	ACSa-27.3/240-950	电阻丝 Resistance Wires	连续式 Continuous	Φ273×2400	950	SUS310S	27	有效产能: 8L/h; 转速: 0-5rpm; 气体流量: 20m³/h Effective capacity: 8L/h; Speed: 0-5rpm; Gas flow: 20m³/h
R4CA9.5	ACSa-40/550-950	电阻丝 Resistance Wires	连续式 Continuous	Φ400×5500	950	SUS310S	90	产能: 24kg/h(比重: 0.5t/m³); 转速: 0-3rpm; 气体流量: 20L/min Capacity: 24kg/h (specific gravity: 0.5t/m³); Speed: 0-3rpm; Gas flow: 20L/min
R6CA9.5	ACSa-60/600-950	电阻丝 Resistance Wires	连续式 Continuous	Φ600×6000	950	镍基合金 Nickel-based alloys	160	产能: 80kg/h(比重: 0.5t/m³); 转速: 0-3rpm; 气体流量: 200m³/min Capacity: 80kg/h (specific gravity: 0.5t/m³); Speed: 0-3rpm; Gas flow: 200m³/min
R13CA9.5	ACSa-130/1300-950	电阻丝 Resistance Wires	连续式 Continuous	Φ1300×13000	950	SUS321	330	产能: 1500kg/h(比重: 0.5t/m³); 转速: 0-5rpm; 气体流量: 120m³/h Capacity: 1500kg/h (specific gravity: 0.5t/m³); Speed: 0-5rpm; Gas flow: 120m³/h

应用领域 / APPLICATIONS

适用材料：锂电正负极材料、磁性材料、纳米材料等粉体材料。
制备石墨负极材料专用设备，可作为二烧设备。

The sintering process has been widely used in many industrial industries such as steel industry, metallurgical industry, ceramic industry, etc., such as cemented carbide, ceramics, refractories, powder metallurgy, ultra-high temperature material ring, etc..



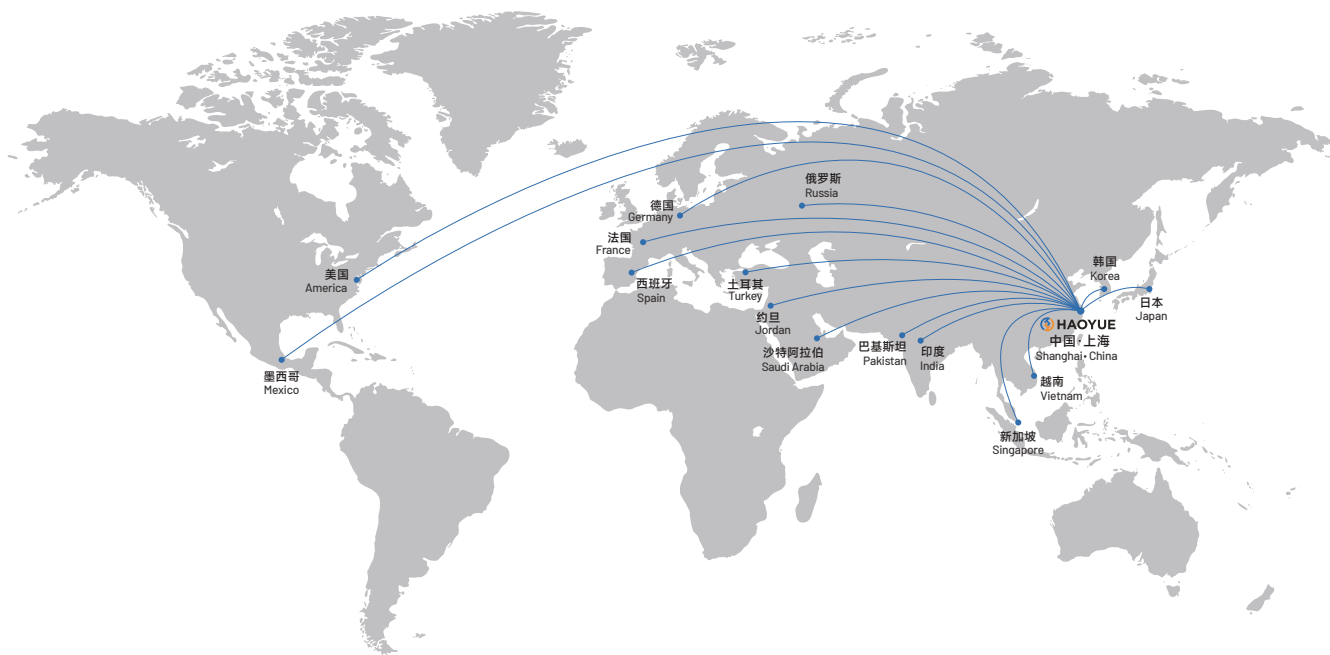

上海皓越真空设备有限公司

SHANGHAI HAORYUE TECHNOLOGY CO.,LTD

办公地址：上海市嘉定区嘉松北路7301号B2栋

Office Add: Building B2, No.7301, Jiasong North Road, Jiading District, Shanghai

工厂地址：江苏省南通市通州区聚丰科创产业园1号厂房

Factory Add: No.1, Jufeng Science and Technology Industrial Park, Tongzhou District, Nantong, Jiangsu

电话 (Tel): 86-21-51095287 传真 (Fax): 86-21-51095281

邮箱 (E-mail): sale@haoyue-group.com (国内) sales@haoyue-group.com (国外)



扫码关注“皓越公众号”